

Errata

Title & Document Type: 35660A Dynamic Signal Analyzer Service Manual

Manual Part Number: 35660-90050

Revision Date: October 1, 1988

HP References in this Manual

This manual may contain references to HP or Hewlett-Packard. Please note that Hewlett-Packard's former test and measurement, semiconductor products and chemical analysis businesses are now part of Agilent Technologies. We have made no changes to this manual copy. The HP XXXX referred to in this document is now the Agilent XXXX. For example, model number HP8648A is now model number Agilent 8648A.

About this Manual

We've added this manual to the Agilent website in an effort to help you support your product. This manual provides the best information we could find. It may be incomplete or contain dated information, and the scan quality may not be ideal. If we find a better copy in the future, we will add it to the Agilent website.

Support for Your Product

Agilent no longer sells or supports this product. You will find any other available product information on the Agilent Test & Measurement website:

www.tm.agilent.com

Search for the model number of this product, and the resulting product page will guide you to any available information. Our service centers may be able to perform calibration if no repair parts are needed, but no other support from Agilent is available.



0 97556

Agilent Labs Library
MS 26U-1 Palo Alto
(650) 485-5205

SERVICE MANUAL

MODEL HP 35660A
Dynamic Signal Analyzer

Manual Part No. 35660-90050
Microfiche Part No. 35660-90250

© Copyright 1988 Hewlett-Packard Company
8600 Soper Hill Road
Everett, Washington 98205-1298 U.S.A.

Printed: October 1988



CERTIFICATION

Hewlett-Packard Company certifies that this product met its published specifications at the time of shipment from the factory. Hewlett-Packard further certifies that its calibration measurements are traceable to the United States National Bureau of Standards, to the extent allowed by the Bureau's calibration facility, and the calibration facilities of other International Standards Organization Members.

WARRANTY

This Hewlett-Packard product is warranted against defects in material and workmanship for a period of one year from date of shipment. During the warranty period, Hewlett-Packard Company will, at its option, either repair or replace products which prove to be defective.

For warranty service or repair, this product must be returned to a service facility designated by -hp-. Buyer shall prepay shipping charges to -hp- and -hp- shall pay shipping charges to return the product to Buyer. However, Buyer shall pay all shipping charges, duties, and taxes for products returned to -hp- from another country.

HP software and firmware products which are designated by HP for use with a hardware product, when properly installed on the hardware product, are warranted not to fail to execute their programming instructions due to defects in materials and workmanship. If HP receives notice of such defects during their warranty period, HP shall repair or replace software media and firmware which do not execute their programming instructions due to such defects. HP does not warrant that the operation of the software, firmware or hardware shall be uninterrupted or error free.

LIMITATION OF WARRANTY

The foregoing warranty shall not apply to defects resulting from improper or inadequate maintenance by Buyer, Buyer-supplied software or interfacing, unauthorized modification or misuse, operation outside of the environmental specifications for the product, or improper site preparation or maintenance.

NO OTHER WARRANTY IS EXPRESSED OR IMPLIED. HEWLETT-PACKARD SPECIFICALLY DISCLAIMS THE IMPLIED WARRANTIES OF MERCHANTABILITY AND FITNESS FOR PARTICULAR PURPOSE.

EXCLUSIVE REMEDIES

THE REMEDIES PROVIDED HEREIN ARE BUYER'S SOLE AND EXCLUSIVE REMEDIES. HEWLETT-PACKARD SHALL NOT BE LIABLE FOR ANY DIRECT, INDIRECT, SPECIAL, INCIDENTAL, OR CONSEQUENTIAL DAMAGES, WHETHER BASED ON CONTRACT, TORT, OR ANY OTHER LEGAL THEORY.

ASSISTANCE

Product maintenance agreements and other customer assistance agreements are available for Hewlett-Packard products.

For any assistance, contact your nearest Hewlett-Packard Sales and Service Office. Addresses are provided at the back of this manual.



**HEWLETT
PACKARD**

SAFETY SUMMARY

The following general safety precautions must be observed during all phases of operation, service, and repair of this instrument. Failure to comply with these precautions or with specific warnings elsewhere in this manual violates safety standards of design, manufacture, and intended use of the instrument.

Hewlett-Packard Company assumes no liability for the customer's failure to comply with these requirements. This is a Safety Class 1 instrument.

GROUND THE INSTRUMENT

To minimize shock hazard, the instrument chassis and cabinet must be connected to an electrical ground. The instrument is equipped with a three-conductor ac power cable. The power cable must either be plugged into an approved three-contact electrical outlet or used with a three-contact to two-contact adapter with the grounding wire (green) firmly connected to an electrical ground (safety ground) at the power outlet. The power jack and mating plug of the power cable meet International Electrotechnical Commission (IEC) safety standards.

DO NOT OPERATE IN AN EXPLOSIVE ATMOSPHERE

Do not operate the instrument in the presence of flammable gases or fumes. Operation of any electrical instrument in such an environment constitutes a definite safety hazard.

KEEP AWAY FROM LIVE CIRCUITS

Operating personnel must not remove instrument covers. Component replacement and internal adjustments must be made by qualified maintenance personnel. Do not replace components with power cable connected. Under certain conditions, dangerous voltages may exist even with the power cable removed. To avoid injuries, always disconnect power and discharge circuits before touching them.

DO NOT SERVICE OR ADJUST ALONE

Do not attempt internal service or adjustment unless another person, capable of rendering first aid and resuscitation, is present.

DO NOT SUBSTITUTE PARTS OR MODIFY INSTRUMENT

Because of the danger of introducing additional hazards, do not install substitute parts or perform any unauthorized modification to the instrument. Return the instrument to a Hewlett-Packard Sales and Service Office for service and repair to ensure the safety features are maintained.

DANGEROUS PROCEDURE WARNINGS

Warnings, such as the example below, precede potentially dangerous procedures throughout this manual. Instructions contained in the warnings must be followed.

WARNING

Dangerous voltages, capable of causing death, are present in this instrument. Use extreme caution when handling, testing, and adjusting.

SAFETY SYMBOLS

General Definitions of Safety Symbols Used On Equipment or In Manuals.



Instruction manual symbol: the product will be marked with this symbol when it is necessary for the user to refer to the instruction manual in order to protect against damage to the instrument.



Indicates dangerous voltage (terminals fed from the interior by voltage exceeding 1000 volts must be so marked.)

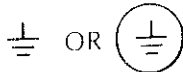

Protective conductor terminal. For protection against electrical shock in case of a fault. Used with field wiring terminals to indicate the terminal which must be connected to ground before operating equipment.



Low-noise or noiseless, clean ground (earth) terminal. Used for a signal common, as well as providing protection against electrical shock in case of a fault. A terminal marked with this symbol must be connected to ground in the manner described in the installation (operating) manual, and before operating the equipment.



Frame or chassis terminal. A connection to the frame (chassis) of the equipment which normally includes all exposed metal structures.



Alternating current (power line.)



Direct (power line.)



Alternating or direct current (power line.)

WARNING The **WARNING** sign denotes a hazard. It calls attention to a procedure, practice, condition or the like, which if not correctly performed or adhered to, could result in injury or death to personnel.

CAUTION The **CAUTION** sign denotes a hazard. It calls attention to an operating procedure, practice, condition or the like, which, if not correctly performed or adhered to, could result in damage to or destruction of part or all of the product.

NOTE The **NOTE** sign denotes important information. It calls attention to procedure, practice, condition or the like, which is essential to highlight.

Table of Contents

SECTION I GENERAL INFORMATION

How This Manual is Organized	1-1
Safety Considerations	1-3
Grounding	1-3
Recommended Test Equipment	1-4
Accessories	1-6

SECTION II Installation Guide (with Performance Tests)

SECTION III ADJUSTMENTS

Introduction	3-1
Remote Operation	3-3
Equipment Required	3-3
Safety Considerations	3-3
Frequency Reference	3-4
Second Pass Gain	3-5
ADC Offset and Reference	3-7
Input DC Offset	3-10
Common Mode Rejection	3-12
Filters Flatness	3-14
Display	3-16

SECTION IV REPLACEABLE PARTS

Introduction	4-1
Ordering Information	4-2
Ordering Assemblies	4-2
Ordering Listed Parts	4-3
Ordering Non-Listed Parts	4-3
Direct Mail Order System	4-3
Replaceable Parts List	4-4

SECTION V MANUAL BACKDATING

Introduction	5-1
Manual Changes Supplement	5-2
Summary	5-2
Manual Change Instructions	5-2

SECTION VI CIRCUIT DESCRIPTIONS

Introduction	6-1
Overall Instrument Description	6-1
Assembly Mnemonics and Locations	6-2
Overall Block Diagram	6-2
Assembly Descriptions	6-7
BNC Connector board (BNC CONN)	6-7
Input 1 Assembly (INPUT 1)	6-8
Input 2/ADC Assembly (INP2/ADC)	6-14
Digital Processor Assembly (DGTL PROC)	6-22
CPU Assembly (CPU)	6-25
Memory Assembly (MEM)	6-33
Expanded Memory Assembly (EXP MEM)	6-33
External Trigger Assembly (EX TRIG)	6-34
Front Panel Assembly	6-34
Power Supply (PWR)	6-34
Disk Drive (DISK)	6-34
Display (DSPL)	6-34
Voltage and Signal Descriptions	6-35
Voltage Distribution	6-35
Interassembly Signals	6-42

**SECTION VII
SERVICE: ASSEMBLY LEVEL**

Introduction	7-1
Safety Considerations	7-1
How to Use This Section	7-2
Choosing a Troubleshooting Test	7-3
What to Do After an Assembly Is Replaced	7-4
Troubleshooting Hints	7-5
Equipment Required	7-5
Initial Verification	7-5
Test 1: Initial Verification	7-5
Troubleshooting Using the Power-On Test	7-10
Test 2: Power-on	7-10
Test 3: CPU, Memory, and Buses	7-13
Test 4: Memory	7-15
Test 5: Display	7-17
Test 6: IIC Bus (Inter-IC Bus)	7-19
Test 7: Fast Bus	7-21
Test 8: Control Lines	7-23
Power-on Test Messages	7-25
Troubleshooting Using the Self Tests	7-27
Test 9: Self Test	7-28
Test 10: All Locks Analyzer	7-33
Test 11: Source/Cal Out	7-36
Test 12: Inputs	7-39
Test 13: Distortion	7-43
Test 14: Trigger	7-44
Test 15: Disc Drive	7-48
Test 16: HP-IB/RS-232	7-51
Test 17: Intermittent Failures	7-52
Calibration Routine Description	7-54
DC-Offset Tables and Frequency Correction Curves	7-55
Calibration Error Messages	7-56
Viewing the Calibration Correction Curves	7-56
Self-Test Descriptions	7-57
Power-on Tests	7-57
Self Tests that Perform a Measurement	7-59
Individual Self-Test Descriptions	7-61
Power-on and Preset States	7-74
States Stored in EEPROM	7-76
Self-Test Menu Map and HP-IB Commands	7-77
How to Set the Serial Number	7-79
Disassembly/Assembly	7-81

**SECTION VIII
SERVICE: COMPONENT LEVEL**

Introduction	8-1
Safety Considerations	8-1
How to Use This Section	8-2
What to Do After a Component Is Replaced	8-3
Troubleshooting Hints	8-4
Equipment Required	8-4
Input Troubleshooting Tests	8-5
Test 1: Input Initial Verification	8-5
Test 2: Signal Amplitudes	8-8
Test 3: Range Setting	8-11
Test 4: Input Setup	8-12
Test 5: Noise and Distortion	8-15
Test 6: Bootstrap	8-18
Test 7: Common Mode Rejection (CMR)	8-21
Test 8: Over-Range	8-22
Test 9: DC Offset	8-23
Test 10: Anti-Alias Filters	8-24
Test 11: Trigger	8-28
ADC Troubleshooting Tests	8-30
Test 12: ADC Initial Verification	8-30
Test 13: Signal Trace	8-34
Test 14: 2nd Pass Mode	8-37
Test 15: Noise and Distortion	8-38
Test 16: Data and Control Lines	8-39
Schematic Logic Symbology	8-40

SECTION I

GENERAL INFORMATION

How This Manual is Organized

This service manual provides all the information required by service personnel to test, adjust, and service the HP 35660A Dynamic Signal Analyzer.

The service manual is divided into eight sections, each covering a particular topic for servicing the HP 35660A. A brief description of these sections and when each section should be used is given in Table 1-1. In addition, a Quick Reference is included at the end of this manual.

Table 1-1. Manual Section Descriptions

Section/Title	Description
I General Information	This section shows you how to use this manual. It also includes Safety Considerations, a list of the Recommended Test Equipment, and available accessories.
II Installation Guide (Includes Performance Tests)	This section contains the HP 35660A Installation Guide. The HP 35660A Installation Guide includes the Operation Verification and Performance Tests, installation and maintenance information, options, specifications, and storage and shipment details.
III Adjustments	This section contains the analyzer's adjustment procedures. Use this section when adjustment is recommended in Sections II, VII and VIII.
IV Replaceable Parts	This section lists replaceable parts for the analyzer. It also includes parts ordering information.
V Manual Backdating	This section contains information to adapt this manual to instruments manufactured prior to the printing of this manual.
VI Circuit Descriptions	This section contains an overall description of the analyzer followed by a detailed description of each assembly in the analyzer. It also includes voltage and signal descriptions.
VII Service: Assembly Level	This section contains troubleshooting procedures to isolate failures to the assembly level. It also contains Disassembly/Assembly illustrations. Use this section to begin troubleshooting the analyzer.

Table 1-1. Manual Section Descriptions (continued)

Section/Title	Description
VIII Service: Component Level	This section contains component-level troubleshooting procedures and schematics for assemblies repaired to the component level. Always start by using Section VII to isolate failures to the assembly level. Then, if Section VII leads you to this section continue to troubleshoot the failing assembly to the component level.
— Quick Reference	This section includes frequently used material such as analyzer block diagrams, assembly locators, inter-assembly cabling diagrams, and component locators.

Safety Considerations

The HP 35660A is a Safety Class 1 instrument (provided with a protective earth terminal). Although this instrument has been designed in accordance with international safety standards, this manual contains information, cautions and warnings which must be followed to ensure safe operation and retain the HP 35660A in safe operating condition. Service and adjustments should be performed by only qualified personnel who are aware of the hazards involved.

Grounding

On the HP-IB connector, pin 12 and pins 18 through 24 are tied to protective earth ground and the HP-IB cable shield. The instrument frame, chassis, covers and all exposed metal surfaces are connected to protective earth ground. The input terminal outer BNC is NOT connected to protective earth ground, and can be raised to a maximum of ± 4 Vpk with respect to instrument chassis.

WARNING *DO NOT interrupt the protective earth ground or "float" the HP 35660A. This action could expose the operator to potentially hazardous voltages.*

Recommended Test Equipment

The following table lists the equipment needed to maintain the HP 35660A Dynamic Signal Analyzer. Other equipment may be substituted for the recommended model if it meets or exceeds the listed critical specifications. When substitutions are made, you may have to modify the performance and adjustment procedures to accommodate the different operating characteristics.

Table 1-2. Recommended Test Equipment

Instrument	Critical Specifications	Recommended Model	Use†
Cables Adapters Resistors Digital Voltmeter AC Calibrator	See **NOTE below	See **NOTE below	P, O, A P, O, T, A P, O P, O, T, A P, O
Frequency Synthesizer‡			P, O, T
Feedthrough Termination			P, O, T
Oscilloscope	Bandwidth: >50MHz Two Channel; External Trigger 1 MΩ Input	HP 54100A Alternatives: HP 1980B HP 1740	A, T
Logic Probe	TTL/CMOS Maximum Clock: >25 MHz	HP 545A Alternatives: HP 5006A HP 5005A HP 5005B	T
Spectrum Analyzer	10 Hz to 100 kHz; Dynamic Range ≥70 dBV	HP 3562A Alternatives: HP 3561A HP 3585A	T
Counter	Freq Range: 0 Hz to 100 MHz Frequency Accuracy: 7.5 ppm or better at 20 MHz	HP 5350G Alternatives: HP 5351B HP 5335A	A

† P = Performance Tests, O = Operation Verification Tests, T = Troubleshooting, A = Adjustments

‡ Option 002, High Voltage Output, is needed in the HP 3325A or HP 3326A for "Test 8: Over-Range" in Section VIII—Service: Component Level.

****NOTE** See "Recommended Test Equipment" in Section II, Installation Guide for critical specifications and recommended model for these cables, adapters, resistors, and instruments.

Table 1-2. Recommended Test Equipment (continued)

Instrument	Critical Specifications	Recommended Model	Use†
Probe, Oscilloscope	Impedance: $\geq 1 \text{ M}\Omega$ Division Ratio: 10:1 Maximum Voltage: $\geq 20 \text{ Vdc}$	HP 54003A Alternatives 10014A 10016B 10004A 10005D	A, T
HP 35660A Service Kit	Includes: Power Supply Test Board Fast Bus Extender Cable Front-Panel Extender Cable Interconnect Extender Cable IIC/Power Extender Cable Phono Cable Phono Plug to BNC Cable SMB to BNC Cable SMB to SMB Adapter Capacitive Load	HP 35660-84401 Includes: HP 35672-66590 HP 35660-61621 HP 35672-61621 HP 35660-61623 HP 35660-61622 HP 8120-4492 HP 03326-61618 HP 03585-61616 HP 1250-0669 HP 35660-64401	A, T

† P = Performance Tests, O = Operation Verification Tests, T = Troubleshooting, A = Adjustments
‡ Option 002, High Voltage Output, is needed in the HP 3325A or HP 3326A for "Test 8: Over-Range"
in Section VIII - Service: Component Level.

Accessories

The following accessories are available for the HP 35660A Dynamic Signal Analyzer.

Table 1-3. Accessories

Accessory	Part Number
Operating Manual Includes:	35660-90000
Installation Guide	35660-90015
Getting Started Guide	35660-90005
Front-Panel Reference	35660-90010
HP-IB Programming Reference	35660-90025
Add 2 Mbyte RAM Includes:	35660-84403
A86 Expanded Memory (opt 001)	35672-66586
Installation Note	35660-90022
Power Cords:	
U.K.	5041-5807
Australia, New Zealand	5041-5808
European Continent	5041-5809
USA, Canada, Japan	5041-5819
Switzerland	5041-5812
Rack Mount Kit	35660-86010

SECTION II
INSTALLATION GUIDE
Includes Part, Test

HEWLETT-PACKARD

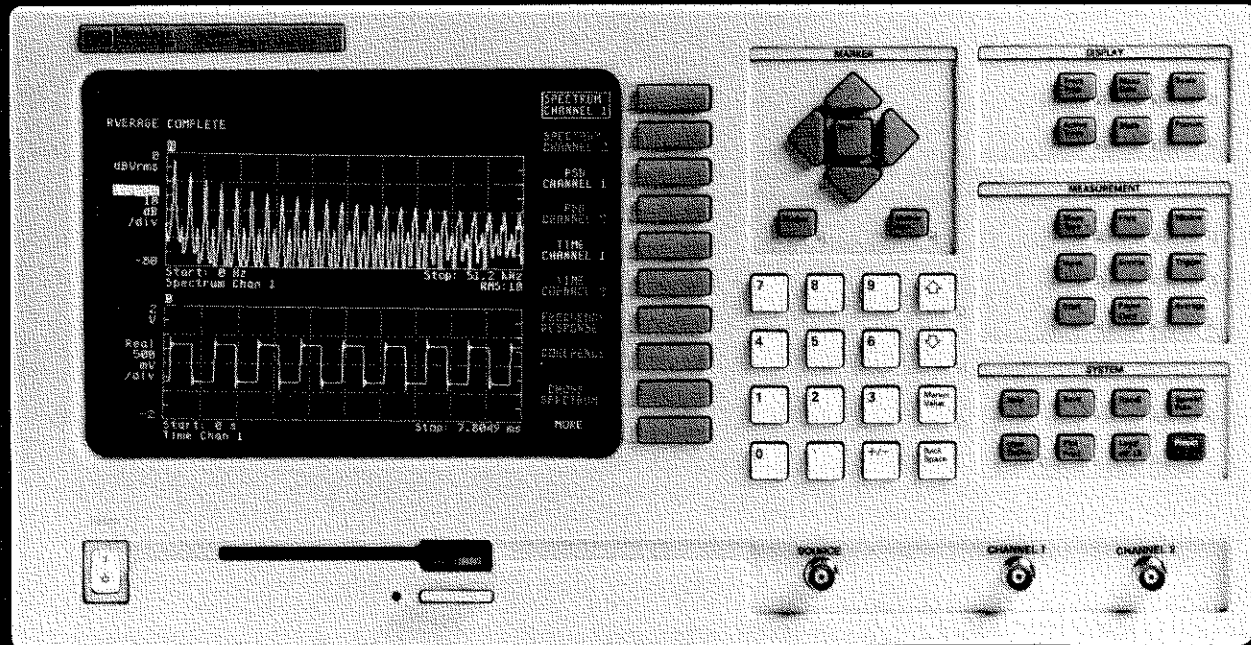

HP 35660A Dynamic Signal Analyzer Installation Guide



HEWLETT
PACKARD

HP 35660A Dynamic Signal Analyzer Installation Guide

Includes:

Operation Verification Tests
Performance Tests
Specifications

Manual Part No. 35660-90015
Microfiche Part No. 35660-90215

© Copyright Hewlett-Packard Company 1988
8600 Soper Hill Road
Everett, Washington 98205-1298 U.S.A.

Printed: July 1988



CERTIFICATION

Hewlett-Packard Company certifies that this product met its published specifications at the time of shipment from the factory. Hewlett-Packard further certifies that its calibration measurements are traceable to the United States National Bureau of Standards, to the extent allowed by the Bureau's calibration facility, and the calibration facilities of other International Standards Organization Members.

WARRANTY

This Hewlett-Packard product is warranted against defects in material and workmanship for a period of one year from date of shipment. During the warranty period, Hewlett-Packard Company will, at its option, either repair or replace products which prove to be defective.

For warranty service or repair, this product must be returned to a service facility designated by HP. Buyer shall prepay shipping charges to HP and HP shall pay shipping charges to return the product to Buyer. However, Buyer shall pay all shipping charges, duties, and taxes for products returned to HP from another country.

HP software and firmware products which are designated by HP for use with a hardware product, when properly installed on the hardware product, are warranted not to fail to execute their programming instructions due to defects in materials and workmanship. If HP receives notice of such defects during their warranty period, HP shall repair or replace software media and firmware which do not execute their programming instructions due to such defects. HP does not warrant that the operation of the software, firmware or hardware shall be uninterrupted or error free.

LIMITATION OF WARRANTY

The foregoing warranty shall not apply to defects resulting from improper or inadequate maintenance by Buyer, Buyer-supplied software or interfacing, unauthorized modification or misuse, operation outside of the environmental specifications for the product, or improper site preparation or maintenance.

NO OTHER WARRANTY IS EXPRESSED OR IMPLIED. HEWLETT-PACKARD SPECIFICALLY DISCLAIMS THE IMPLIED WARRANTIES OF MERCHANTABILITY AND FITNESS FOR PARTICULAR PURPOSE.

EXCLUSIVE REMEDIES

THE REMEDIES PROVIDED HEREIN ARE BUYER'S SOLE AND EXCLUSIVE REMEDIES. HEWLETT-PACKARD SHALL NOT BE LIABLE FOR ANY DIRECT, INDIRECT, SPECIAL, INCIDENTAL, OR CONSEQUENTIAL DAMAGES, WHETHER BASED ON CONTRACT, TORT, OR ANY OTHER LEGAL THEORY.

ASSISTANCE

Product maintenance agreements and other customer assistance agreements are available for Hewlett-Packard products.

For any assistance, contact your nearest Hewlett-Packard Sales and Service Office. Addresses are provided at the back of this manual.



SAFETY SUMMARY

The following general safety precautions must be observed during all phases of operation, service, and repair of this instrument. Failure to comply with these precautions or with specific warnings elsewhere in this manual violates safety standards of design, manufacture, and intended use of the instrument.

Hewlett-Packard Company assumes no liability for the customer's failure to comply with these requirements. This is a Safety Class 1 instrument.

GROUND THE INSTRUMENT

To minimize shock hazard, the instrument chassis and cabinet must be connected to an electrical ground. The instrument is equipped with a three-conductor ac power cable. The power cable must either be plugged into an approved three-contact electrical outlet or used with a three-contact to two-contact adapter with the grounding wire (green) firmly connected to an electrical ground (safety ground) at the power outlet. The power jack and mating plug of the power cable meet International Electrotechnical Commission (IEC) safety standards.

DO NOT OPERATE IN AN EXPLOSIVE ATMOSPHERE

Do not operate the instrument in the presence of flammable gases or fumes. Operation of any electrical instrument in such an environment constitutes a definite safety hazard.

KEEP AWAY FROM LIVE CIRCUITS

Operating personnel must not remove instrument covers. Component replacement and internal adjustments must be made by qualified maintenance personnel. Do not replace components with power cable connected. Under certain conditions, dangerous voltages may exist even with the power cable removed. To avoid injuries, always disconnect power and discharge circuits before touching them.

DO NOT SERVICE OR ADJUST ALONE

Do not attempt internal service or adjustment unless another person, capable of rendering first aid and resuscitation, is present.

DO NOT SUBSTITUTE PARTS OR MODIFY INSTRUMENT

Because of the danger of introducing additional hazards, do not install substitute parts or perform any unauthorized modification to the instrument. Return the instrument to a Hewlett-Packard Sales and Service Office for service and repair to ensure the safety features are maintained.

DANGEROUS PROCEDURE WARNINGS

Warnings, such as the example below, precede potentially dangerous procedures throughout this manual. Instructions contained in the warnings must be followed.

WARNING

Dangerous voltages, capable of causing death, are present in this instrument. Use extreme caution when handling, testing, and adjusting.

SAFETY SYMBOLS

General Definitions of Safety Symbols Used On Equipment or In Manuals.



Instruction manual symbol: the product will be marked with this symbol when it is necessary for the user to refer to the instruction manual in order to protect against damage to the instrument.



Indicates dangerous voltage (terminals fed from the interior by voltage exceeding 1000 volts must be so marked.)

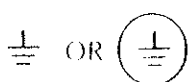

Protective conductor terminal. For protection against electrical shock in case of a fault. Used with field wiring terminals to indicate the terminal which must be connected to ground before operating equipment.



Low-noise or noiseless, clean ground (earth) terminal. Used for a signal common, as well as providing protection against electrical shock in case of a fault. A terminal marked with this symbol must be connected to ground in the manner described in the installation (operating) manual, and before operating the equipment.

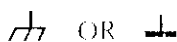

Frame or chassis terminal. A connection to the frame (chassis) of the equipment which normally includes all exposed metal structures.



Alternating current (power line.)



Direct (power line.)



Alternating or direct current (power line.)

WARNING *The WARNING sign denotes a hazard. It calls attention to a procedure, practice, condition or the like, which if not correctly performed or adhered to, could result in injury or death to personnel.*

CAUTION *The CAUTION sign denotes a hazard. It calls attention to an operating procedure, practice, condition or the like, which, if not correctly performed or adhered to, could result in damage to or destruction of part or all of the product.*

NOTE *The NOTE sign denotes important information. It calls attention to procedure, practice, condition or the like, which is essential to highlight.*

Table of Contents

Introducing the HP 35660A	1-1	9. Single Channel Phase Accuracy	3-33
About the HP 35660A	1-1	10. Input Impedance	3-36
About this Guide	1-1	11. Harmonic Distortion	3-42
Options	1-2	12. Intermodulation Distortion	3-46
Serial Numbers	1-3	13. Noise and Spurious Signals	3-50
Software Revision Code	1-4	14. Cross talk	3-55
Specifications	2-1	15. Source Residual DC Offset	3-60
Operation Verification Tests and Performance Tests	3-1	16. Source Amplitude Accuracy and Flatness ...	3-62
Introduction	3-1	17. Source Output Distortion	3-66
Test Duration	3-1	18. Source Output Resistance	3-69
Calibration Cycle	3-1	HP 35660A Installation	4-1
Operation Verification and Performance Test List	3-2	Getting Ready	4-1
Specification Versus Performance Tests	3-3	Incoming Inspection	4-1
Recommended Test Equipment	3-4	Incoming Tests	4-1
How To Perform An Operation Verification or Performance Test	3-6	Dimensions and Weight	4-2
Operation Verification Test Record	1 thru 6	Power Requirements	4-2
Performance Test Record	1 thru 8	Power Cable and Grounding Requirements ..	4-4
1. Self Test	3-7	Screen (CRT) Cleaning	4-5
2. DC Response	3-8	Analyzer Cooling	4-5
3. Amplitude Accuracy and Flatness	3-11	Installation	4-5
4. Amplitude Linearity	3-16	HP-IB System Interface Connections	4-6
5. Amplitude and Phase Match	3-19	Turning on the HP 35660A	4-5
6. Anti-Alias Filter Response	3-23	Operating Environment	4-6
7. Frequency Accuracy	3-27	Storage and Shipment	4-8
8. Input Coupling Insertion Loss	3-30	Storage	4-8
		Shipment	4-8
		Index	

Chapter 1

Introducing the HP 35660A

About the HP 35660A

The HP 35660A Dynamic Signal Analyzer is both a one-channel and a two-channel FFT signal analyzer. As a one-channel analyzer its frequency measurement range is from 488 μ Hz to 102.4 kHz; as a two-channel analyzer its frequency measurement range is from 244 μ Hz to 51.2 kHz. The analyzer also contains a built-in signal source and disc drive (however, the disc drive may be deleted).

On the front panel there are three active BNC connectors: channel 1 input, channel 2 input, and a source output. On the rear panel there are also three connectors: a BNC connector for an external trigger input, a 25-pin connector for the HP-IB, and a 9-pin connector (currently inactive).

About this Guide

The HP 35660A Installation Guide contains installation and operating information, along with the operation verification tests and performance tests. It is, therefore, included as part of the *HP 35660A Operating Manual Set* with an additional copy inserted into the optional *HP 35660A Service Manual*.

This book is organized with the specifications, operation verification tests, and performance tests near the beginning and the installation information at the back of the guide.

Options

The following options are available for the HP 35660A:

- 001 Add 2 Mbyte RAM
- 002 Delete disc drive
- 908 Rack mount kit (HP P/N 35660-86010)
- 910 Extra Operating Manual Set and HP-IB Programming Reference
- 915 Service Package
 - Service manual (HP P/N 35660-90050)
 - Service kit (HP P/N 35660-844401)
- 916 Extra operating Manual
 - Similar to option 910, except does not include HP-IB Programming Reference
- 920 Extra HP-IB Programming Reference
- W30 Adds an additional 2 years to standard warranty
(for a total of 3-years warranty)

Serial Numbers

This guide, as with all HP 35660A manuals, applies to analyzers with the serial number prefixes listed under SERIAL NUMBERS on the title page.

Hewlett-Packard makes frequent improvements to its products to enhance their performance, usability, or reliability, and to control costs. HP service personnel have access to complete records for each type of equipment, based on the equipment's serial number. Whenever you contact HP about your analyzer, have the complete serial number available to ensure obtaining the most complete and accurate information possible.

A serial number label is attached to the rear of the analyzer. The serial number has two parts: the prefix (the first four numbers and a letter), and the suffix (the last five numbers).

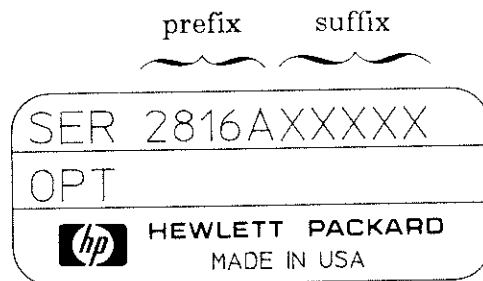

Software Revision Code

As with changes to the instrument hardware, Hewlett-Packard also makes changes to its software. To determine which version of software is in your analyzer, press the following keys:

< SPECIAL FCTN >

[Fault Log]

[Version]

An information block appears on the screen for about five seconds (pressing [Version] repeats the information). The first line of this information block contains the software version code.

Chapter 2

Specifications

Specifications describe the instrument's warranted performance and apply within $\pm 5^\circ\text{C}$ and 2 hours of last self-calibration. Specifications designated as "Typical" reflect supplemental, non-warranted characteristics.

Amplitude

Input Range: +27 dBV (31.7 Vpk) to -51 dBV (3.99 mVpk). Range is adjustable in 2 dB increments.

Dynamic Range: 70 dB
The following undesired responses will be < -70 dB relative to full scale input range:

Harmonic Distortion
Intermodulation Distortion
Alias Responses
Spurious or Residual Responses

Noise: (-51 dBV range, $R_s = 50\Omega$, 16 rms averages)

160 Hz to 1.28 kHz < -130 dBV/ $\sqrt{\text{Hz}}$
(.316 $\mu\text{V}/\sqrt{\text{Hz}}$)

1.28 kHz to 102.4 kHz < -140 dBV/ $\sqrt{\text{Hz}}$
(.100 $\mu\text{V}/\sqrt{\text{Hz}}$)

NOTE: The following table shows the maximum span for each range at which noise will be < -70 dB relative to full scale for frequencies > 1.28 kHz. If you are using a span equal to or narrower than the spans shown below for each window/range combination, noise will not limit dynamic range.

Window Types

Ranges (dBV)	Uniform	Hann	Flat Top
+27 to -39	102.4 kHz	102.4 kHz	102.4 kHz
-41	102.4 kHz	102.4 kHz	51.2 kHz
-43	102.4 kHz	102.4 kHz	51.2 kHz
-45	102.4 kHz	51.2 kHz	25.6 kHz
-47	51.2 kHz	51.2 kHz	12.8 kHz
-49	25.6 kHz	25.6 kHz	12.8 kHz
-51	25.6 kHz	12.8 kHz	6.4 kHz

Common Mode Rejection:

(Frequency ≤ 1 kHz)

-51 to -11 dBV Ranges > 80 dB (Typical)
(3.99 mVpk to 399 mVpk)

-9 to +9 dBV Ranges > 60 dB (Typical)
(502 mVpk to 3.99 Vpk)

+11 to +27 dBV Ranges > 40 dB (Typical)
(5.02 Vpk to 31.7 Vpk)

Crosstalk :

< -130 dB relative to the transmitting signal, or < -70 dB relative to the receiving channel range, whichever is greater.
(Receiving channel $R_s = 50\Omega$)

NOTE: This specification applies to both channel-to-channel and source-to-input crosstalk.

Residual DC Response:

Input Range (dBV)	DC Level
+27 to -35 (31.7 Vpk to 25.1 mVpk)	< -30 dB relative to full scale
-37 to -51 (20.0 mVpk to 3.99 mVpk) ($R_s = 50\Omega$)	< -20 dB relative to full scale

Absolute Amplitude Accuracy:

± 0.5 dB ± 0.03 % of input range
(488 μHz to 102.4 kHz, DC coupled)

Worst case absolute amplitude accuracy is the sum of full scale accuracy, linearity, and flatness at any of the 401 calculated frequency points. If the input signal is not at the center of a frequency bin, the accuracy of the measured signal will be the sum of absolute amplitude accuracy and the flatness specification for that particular window (see window shape parameters).

Full Scale Accuracy: ± 0.15 dB
(at 1 kHz)

Linearity: ± 0.15 dB ± 0.03 % of range
(at 1 kHz)

Flatness: ± 0.2 dB
(relative to 1 kHz, DC coupled)

Frequency

Measurement Range:

Channel 1: 488 μ Hz to 102.4 kHz, single channel mode
 Channel 1 and 2: 244 μ Hz to 51.2 kHz, dual channel mode.

Accuracy:

$\pm 0.003\%$ of frequency reading

Resolution:

Span/400, both channels, single or dual channel operation.

Spans:

	Single Channel	Dual Channel
# of spans available	20 (x2 sequence)	20 (x2 sequence)
min. span	195.3 mHz	97.6 mHz
max. span	102.4 kHz	51.2 kHz
time record length	400/span	400/span

of spans available
 min. span
 max. span
 time record length

20 (x2 sequence)
 195.3 mHz
 102.4 kHz
 400/span

Dual Channel
 20 (x2 sequence)
 97.6 mHz
 51.2 kHz
 400/span

Window Functions:

Flat Top, Hann, Uniform, Force, Exponential

Window Shape Parameters:

	Noise Equiv. BW (% of span)	-3dB BW (% of span)	Shape Factor (-60dB BW/-3 dB BW)	Window Flatness (dB)*
Uniform	0.25	0.25	716	+0, -4.0
Hann	0.375	0.37	9.1	+0, -1.5
Flat Top	0.955	0.9	2.6	± 0.005

* relative to analyzer's 401 calculated frequency points (spectral lines)

The HP 35660A functions as if the input signal were applied to a bank of 401 narrow-band filters in parallel. The drawings at right show the response of a single filter in the frequency domain when using Uniform, Hann or Flat Top windows. The left side of each drawing represents the center of the filter. The horizontal axis shows frequency offset (in unit of Δf) from the center of the filter. The units of Δf represent the spacing between adjacent bin centers. Only positive offsets are shown, as each filter is symmetrical. NOTE: HP 35660A marker frequencies fall at the center of each filter.

Typical Realtime Bandwidth: (random noise source off)

	Single Channel	Dual Channel
Averaging Off	800 Hz	400 Hz
Fast Averaging	3.2 kHz	1.6 kHz

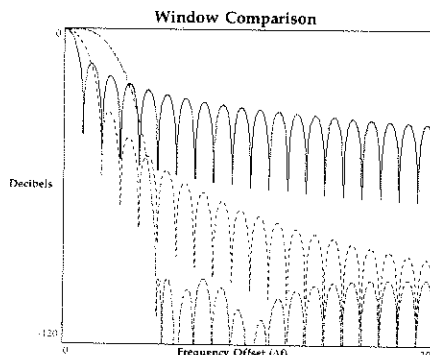
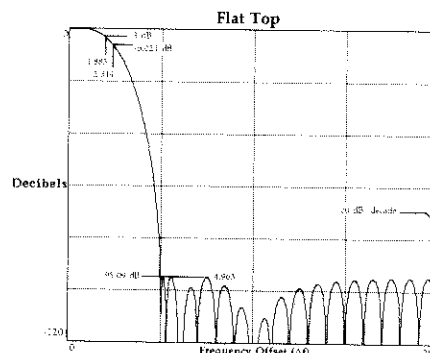
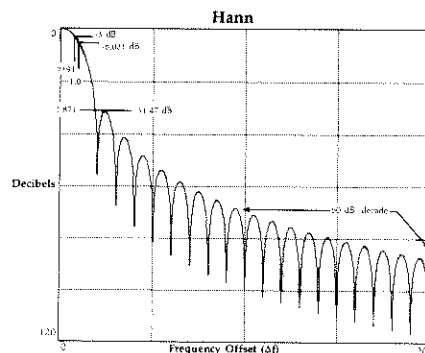
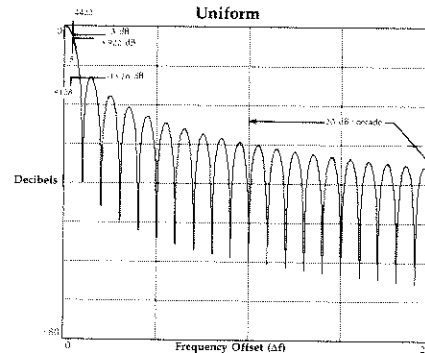

Phase

Single Channel Phase Accuracy: 488 uHz to 10.24 kHz $\pm 4.0^\circ$
(relative to external trigger, 16 vector averages, amplitude ≥ -50 dB relative to full scale, DC coupled)

NOTE: For Hann or Flat Top windows, phase is relative to the center of the time record. For the Uniform, Force, and Exponential windows, phase is relative to the beginning of the time record.

Frequency Response

Gain Accuracy: ± 0.4 dB

Phase Accuracy: 488 uHz to 10.24 kHz $\pm 1^\circ$
10.24 kHz to 102.4 kHz $\pm 1.8^\circ$
(DC coupled, 16 rms averages, 488 μ Hz to 51.2 kHz, Ch1 range = Ch2 range, full scale periodic chirp input, Uniform window)

Inputs

Connection: Grounded or Floating

Input Impedance: 1 M Ω $\pm 10\%$ shunted by < 100 pF
Low to chassis in floating mode:
1 M Ω shunted by < 0.01 μ F (Typical)
Low to chassis in grounded mode: 50 Ω (Typical)

Input Coupling: AC or DC coupling;
AC roll-off is < 3 dB at 1 Hz

Common Mode Range: ± 4 V peak
(floating mode)

Source

Random, periodic chirp, fixed sine outputs are available from the front panel SOURCE output.

Output Impedance: < 5 Ω

Max. Output Level: ± 5 Vpk

Max. Current: ± 20 mA

Max. Capacitive Load: 1000 pF

Sine: Frequency range:
15.63 mHz to 102.4 kHz

Amplitude Accuracy:
 $\pm 4\%$ Vpk (at 1 kHz, Vpk = .1V to 5V)

Flatness: ± 1.0 dB
(relative to 1 kHz, Vpk = .1V to 5V)

Harmonic, subharmonic, and other spurious responses:

488 μ Hz to 10 kHz:
< -60 dB relative to fundamental

10 kHz to 102.4kHz:
< -40 dB relative to fundamental
(Vpk = 0.1V to 5V)

Residual DC offset:
 ± 8.0 mV, $\pm 6.0\%$ Vpk

Random: Flatness: < 5.0 dB (Typical)
(passband, relative to minimum amplitude in the frequency domain, Vpk = .1V to 5V, full span)

Crest factor (Vpk/Vrms): 2.5 (Typical)
(center frequency > 0.7 * span frequency)

Trigger

Internal: Positive or negative slope
Level range: $\pm 100\%$ of input range

External: TTL, positive or negative slope

Delay: Pre-trigger: from 0 to 6 samples less than 8 time records. Resolution is 1 sample.

Post-trigger: from 0 to 8191 seconds. Resolution is 1 sample.
(1 sample = time record (secs)/1024)

NOTE: the relative trigger delay between channel 1 and 2 can be no more than ± 7 time records. As you set delay on one channel, the analyzer will automatically adjust delay on the other channel, so that the difference in their delay does not exceed 7 time records.

Power: 90 - 132 VAC, 48 to 440 Hz
198 - 264 VAC, 48 to 66 Hz
280 VA maximum

Weight: 22 kg (47 lbs) net
24 kg (52 lbs) shipping

Dimensions: 222 mm (8.75 in) high
425.5 mm (16.75 in) wide
538 mm (21.19 in) deep

HP-IB: Implementation of IEEE Std 488.1 & 488.2
SH1 AH1 T6 TE0 L4 LE0 SR1 RL1 PP0
DC1 DT1 C1,C2,C3,C12 E2

Peripherals: Disc Drives: SS/80 Protocol Disc Drives
Plotters: Hewlett-Packard Graphics Language (HP-GL) digital plotters
Printers: HP-IB printers, alpha and raster dumps.
(See ordering guide for a list of peripherals and accessories.)

General

Environmental Specifications:

Standard Instrument:

	Operating	Storage (no disc in drive)
Temperature	5° to 50° C	-20° to 60° C
Humidity	min. 8% max. 80% at 30° C non-condensing	5 to 95% non-condensing
Altitude	2150 m (7000 ft)	15,200 m (50,000 ft)

Abbreviations: dBV = dB relative to 1 volt rms.
Rs = Resistance of source or termination connected to input.

Delete Disc Option:

	Operating	Storage
Temperature	0° to 55° C	-40° to 70° C
Humidity	min. 5% max. 95% at 40° C	min. 5% max. 95% at 40° C
Altitude	4570 m (15,000 ft)	15,200 m (50,000 ft)

Chapter 3

Operation Verification Tests and Performance Tests

Introduction

This section contains the operation verification tests and the performance tests. The operation verification tests give a high confidence level (>90%) that the instrument is operating properly and within specifications. Operation verification should be used for incoming and after-repair inspections.

The performance tests provide the highest level of confidence and are used to verify that the instrument conforms to its published specifications. Some repairs require a performance test to be done after the repair (see the *HP 35660A Service Manual* for this information).

Test Duration

Operation Verification Tests require approximately 2 hours to complete. The performance tests require approximately 4 hours to complete.

CAUTION Before applying line power to the analyzer or testing its electrical performance, see Chapter 4, "Installation."

Calibration Cycle

To verify the instrument is meeting its published specifications, perform the performance tests every 12 months.

Operation Verification and Performance Test List

The following tables list all the performance tests and operation verification tests.

NOTE To minimize the time required to change instrument configurations between tests, do the tests in the order shown. See How to Perform an Operation Verification or Performance Test following this test list.

Table 3-1 Performance Test and Operation Verification List

Performance Tests	Operation Verification Tests
1. Self Test	1. Self Test
2. DC Response	2. DC Response
3. Amplitude Accuracy and Flatness	3. Amplitude Accuracy and Flatness
4. Amplitude Linearity	5. Amplitude and Phase Match
5. Amplitude and Phase Match	7. Frequency Accuracy
6. Anti-alias Filter Response	9. Single Channel Phase Accuracy
7. Frequency Accuracy	13. Noise and Spurious Signals
8. Input Coupling Insertion Loss	15. Source Residual DC Offset
9. Single Channel Phase Accuracy	16. Source Amplitude Accuracy and Flatness
10. Input Impedance	17. Source Output Distortion
11. Harmonic Distortion	
12. Intermodulation Distortion	
13. Noise and Spurious Signals	
14. Cross Talk	
15. Source Residual DC Offset	
16. Source Amplitude Accuracy and Flatness	
17. Source Output Distortion	
18. Source Output Resistance	

Specification Versus Performance Tests

Table 3-2 Specification Versus Performance Tests

Specification	Performance Test
Frequency	Frequency Accuracy
Absolute Accuracy	Amplitude Accuracy and Flatness Amplitude Linearity
Residual dc Response	DC Response
Frequency Response	Amplitude and Phase Match
Noise Floor	Noise and Spurious Signal Level
Dynamic Range	Anti-Alias Filter Response Harmonic Distortion Intermodulation Distortion
Phase Accuracy	Single Channel Phase Accuracy
Input Impedance	Input Impedance
Input Coupling	Input Coupling Insertion Loss
Cross Talk	Cross Talk
Trigger	Single Channel Phase Accuracy
Source dc Offset	Source Residual DC Offset
Source Accuracy and Purity	Source Amplitude Accuracy and Flatness
Source Distortion	Source Distortion
Source Output Impedance	Source Output Resistance

Recommended Test Equipment

The equipment needed to perform performance tests and operation verification tests the HP 35660A is listed in Table 3-3. Other equipment may be substituted for the recommended model if it meets or exceeds the listed critical specifications.

Table 3-3 Recommended Test Equipment

Instrument	Critical Specifications	Recommended Model
AC Calibrator	10 Hz to 102.4 kHz; 1 mV to 10V Amplitude Accuracy: $\pm .1\%$ phase locking capability	Fluke 5200A Alternative: HP 745A Datron 4200
Frequency Synthesizer	Freq Range: 10 Hz to 1 MHz Frequency Accuracy: ≥ 7.5 ppm Amplitude Accuracy: 0.2 dB from 1 Hz to 100 kHz 1 dB from 100 kHz to 1 MHz Harmonic Distortion: ≤ -70 dBc Spurious: ≤ -70 dBc	HP 3326A Alternative: (2) HP 3325A Opt 001 (1) HP 339A (2) 1 k Ω resistors
Digital Voltmeter	5 1/2 digit True rms ac Voltage: 30 Hz to 100 kHz; 0.1 to 500V; $\pm 0.1\%$; ≥ 1 M Ω input impedance dc Voltage: 1V to 300V; $\pm 0.1\%$	HP 3455A Alternatives: HP 3456A HP 3457A HP 3478A HP 3468A/B
Feedthrough Termination (2)	50 Ω : $\pm 2\%$ at dc	Pomona Elect. Model 4119-50 Alternatives: HP 11048C HP 10100C
Cables (2)	BNC/Dual Banana Dual Banana/Dual Banana Cable BNC/BNC Cable 30 cm BNC/BNC Cable 122 cm	HP11001-60001 HP11000-60001 HP 8120-1838 HP 8120-1840
Adapters	BNC(m) to dual banana plug BNC (f) to dual banana male BNC (f) to BNC (f) BNC Tee (m)(f)(f)	HP 1250-1264 HP 1251-2277 HP 1250-0080 HP 1250-0781
Resistor (2)*	Value: 100 k Ω Accuracy: 1% Power: 0.25W	HP 0757-0465

* see Figure 3-1 for suggested assembly

The following illustration is a suggested assembly for the 100 k Ω Series Resistor. This assembly is required for the following Performance Tests:

- 10. Input Impedance
- 12. Intermodulation Distortion

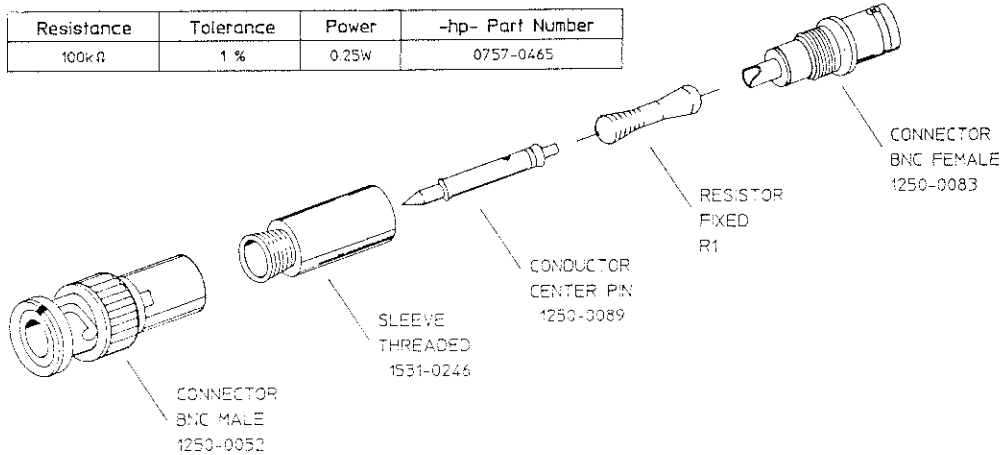

Assembly

1. Cut resistor leads to 12mm on each end.
2. Solder one resistor lead to the center conductor of the BNC FEMALE connector.
3. Solder the CONDUCTOR CENTER PIN to the other lead of the resistor.
4. Screw the SLEEVE and BNC MALE connector into place. Tighten securely.

Figure 3-1. 100 k Ω Series Resistor Assembly

How To Perform An Operation Verification or Performance Test

Use the following procedure to perform the operation verification tests or performance tests:

NOTE The operation verification tests are a subset of the performance tests. At the beginning of each test is a shaded box telling if the test is used for the operation verification test in addition to the performance test. Also this box specifies if there are differences between the two types of tests. Any differences between the operation verification test and the performance test are contained in a shaded box within the test itself.

NOTE The operation verification test and the performance tests must be performed with automatic calibration ON. When the instrument powers up AUTO CAL is ON, do not turn it off.

1. Start each test by setting the test equipment to the test conditions listed in the individual test.
2. There are two types of keys on the HP 35660A, hardkeys and softkeys. The hardkeys are in brackets,

< Freq >

and the softkeys are in braces,

[FREQ SPAN]

For **EXAMPLE**, to set a frequency span of 10 kHz you would do the following:

< Freq >

[SPAN] < 1 > < 0 > [kHz]

In the above example, you first press the hardkey < Freq > followed by the softkey [FREQ SPAN]. Then you enter the number 10 on the numeric keypad and finish by pressing the [kHz] softkey.

3. Record the position of the X and Y markers as indicated for each test. See the *HP35660A Getting Started Guide* for additional information.
4. Record the results of each test in the "Operation Verification Test Record" or the "Performance Test Record." These test records follow and may be reproduced without written permission of Hewlett-Packard.
5. If a test fails, see **IF THIS TEST FAILS** at the end of each test.

HP 35660A Operation Verification Test Record

HP 35660 Tested by _____

Serial No. _____

Customer Name _____

Repair Order No. _____

Date _____

Temperature _____

Relative Humidity _____

Instruments Used:

AC Calibrator

Model _____

Serial No. _____

Frequency Synthesizer

Model _____

Serial No. _____

Digital Voltmeter

Model _____

Serial No. _____

Other _____

Other _____

Operation Verification Test Record

1. Self Test					
			Pass	Fail	
2. DC Offset					
Range Setting	Measured Value		Specification		
	Channel 1	Channel 2			
-51 dBVrms			< -71 dBVrms		
-35 dBVrms			< -65 dBVrms		
3. Amplitude Accuracy and Flatness					
Full Scale Accuracy at 1 kHz:					
Range Setting	AC Calibrator Amplitude	Lower Limit	Upper Limit	Measured Value	
				Channel 1	Channel 2
-51 dBVrms	2.8184 mVrms	-51.15 dBVrms	-50.85 dBVrms		
-27 dBVrms	44.668 mVrms	-27.15 dBVrms	-26.85 dBVrms		
-11 dBVrms	0.28184 Vrms	-11.15 dBVrms	-10.85 dBVrms		
9 dBVrms	2.8184 Vrms	8.85 dBVrms	9.15 dBVrms		
27 dBVrms	22.387 Vrms	26.85 dBVrms	27.15 dBVrms		
Flatness Relative to 1 kHz: CHANNEL 1					
Range Setting	AC Calibrator Amplitude	Signal Frequency	Measured Value	Lower Limit	Upper Limit
-11 dBVrms	0.28184 Vrms	49 kHz		-0.2 dB	0.2 dB
9 dBVrms	2.8184 Vrms	49 kHz		-0.2 dB	0.2 dB
27 dBVrms	22.387 Vrms	49 kHz		-0.2 dB	0.2 dB
9 dBVrms	2.8184 Vrms	99 kHz		-0.2 dB	0.2 dB
27 dBVrms	22.387 Vrms	99 kHz		-0.2 dB	0.2 dB
CHANNEL 2					
Range Setting	AC Calibrator Amplitude	Signal Frequency	Measured Value at 1 kHz dBVrms	Lower Limit	Upper Limit
-11 dBVrms	0.28184 Vrms	49 kHz		-0.2 dB	0.2 dB
9 dBVrms	2.8184 Vrms	49 kHz		-0.2 dB	0.2 dB
27 dBVrms	22.387 Vrms	49 kHz		-0.2 dB	0.2 dB

5. Amplitude and Phase Match					
Frequency Span	Start Frequency	Range Setting	Measurement		Amplitude Limits
			Peak Amplitude	Minimum Amplitude	
6.4 kHz	80 Hz	-23 dBVrms			±0.4 dB
6.4 kHz	3.84 Hz	1 dBVrms			±0.4 dB
51.2 kHz	0 Hz	7 dBVrms			±0.4 dB
			Measurement		Phase Limits
Peak Phase		Minimum Phase			
				±1.0°	
				±1.0°	
				±1.8°	
7. Frequency Accuracy					
Signal Frequency Hz	Lower Limit Hz	Upper Limit Hz	Measured Value		
100 kHz	99.997 kHz		100.003 kHz		
9. Single Channel Phase Accuracy					
Relative to external trigger (TTL Level)					
Signal Frequency	Trigger Slope	Lower Limit	Upper Limit	Measured Value	
				Channel 1	Channel 2
10.24 kHz	Positive	-94°	-86°		
10.24 kHz	Negative	86°	94°		

13. Noise and Spurious Signal Level

Range: -51 dBVrms

Spurious Signals:

Start Frequency	Frequency Span	Measured Value		Specification
		Channel 1	Channel 2	
160 Hz	200 Hz			< -121 dBVrms
360 Hz	200 Hz			< -121 dBVrms
560 Hz	200 Hz			< -121 dBVrms
760 Hz	200 Hz			< -121 dBVrms
1.28 kHz	1.6 kHz			< -121 dBVrms
24 kHz	1.6 kHz			< -121 dBVrms
30 kHz	1.6 kHz			< -121 dBVrms
34.2 kHz	1.6 kHz			< -121 dBVrms
49 kHz	1.6 kHz			< -121 dBVrms
61 kHz	1.6 kHz			< -121 dBVrms
68 kHz	1.6 kHz			< -121 dBVrms
74 kHz	1.6 kHz			< -121 dBVrms
76 kHz	1.6 kHz			< -121 dBVrms
92 kHz	1.6 kHz			< -121 dBVrms
100 kHz	1.6 kHz			< -121 dBVrms

Noise Level:

Range: -51 dBVrms

Start Frequency	Frequency Span	Measured Value		Specification
		Channel 1	Channel 2	
160 Hz	12.8 kHz			< -130 dBV $\sqrt{\text{Hz}}$
1.28 kHz	50 kHz			< -140 dBV $\sqrt{\text{Hz}}$
1.28 kHz	100 kHz			< -140 dBV $\sqrt{\text{Hz}}$

15. Source Residual Offset

Source Level Vpk	Lower Limit	Upper Limit	Measured Value
0.00125V	-8.075 mV	8.075 mV	
5V	-308.0 mV	308.0 mV	

16. Source Amplitude Accuracy and Flatness

Amplitude Accuracy at 1 kHz:

Source Level Vpk	Range Setting Vpk	Lower Limit Vpk	Upper Limit Vpk	Source Amplitude Measured Value
0.1V	0.1V	96.0 mV	104 mV	
3V	3V	2.88V	3.12V	
5V	5V	4.8V	5.2V	

Flatness Relative to 1 kHz:

Signal Frequency	Measured Relative Value dB	Amplitude Limits
1 kHz		
10 kHz		±1 dB
50 kHz		±1 dB
99 kHz		±1 dB

17. Source Output Distortion

Source Frequency	Peak Distortion Value	Specification
10 kHz		< -60 dBc
100 kHz		< -40 dBc

HP 35660A Performance Test Record

HP 35660 Tested by _____

Serial No. _____

Customer Name _____

Repair Order No. _____

Date _____

Temperature _____

Relative Humidity _____

Instruments Used:

AC Calibrator

Model _____

Serial No. _____

Frequency Synthesizer

Model _____

Serial No. _____

Digital Voltmeter

Model _____

Serial No. _____

Other _____

Other _____

Performance Test Record

1. Self Test					
			Pass	Fail	
2. DC Offset					
Range Setting	Measured Value		Specification		
	Channel 1	Channel 2			
-51 dBVrms			< -71 dBVrms		
-35 dBVrms			< -65 dBVrms		
3. Amplitude Accuracy and Flatness					
Full Scale Accuracy at 1 kHz:					
Range Setting	AC Calibrator Amplitude	Lower Limit	Upper Limit	Measured Value	
				Channel 1	Channel 2
-51 dBVrms	2.8184 mVrms	-51.15 dBVrms	-50.85 dBVrms		
-43 dBVrms	7.0795 mVrms	-43.15 dBVrms	-42.85 dBVrms		
-35 dBVrms	17.783 mVrms	-35.15 dBVrms	-34.85 dBVrms		
-27 dBVrms	44.668 mVrms	-27.15 dBVrms	-26.85 dBVrms		
-11 dBVrms	0.28184 Vrms	-11.15 dBVrms	-10.85 dBVrms		
1 dBVrms	1.1220 Vrms	0.85 dBVrms	1.15 dBVrms		
9 dBVrms	2.8184 Vrms	8.85 dBVrms	9.15 dBVrms		
19 dBVrms	8.9125 Vrms	18.85 dBVrms	19.15 dBVrms		
27 dBVrms	22.387 Vrms	26.85 dBVrms	27.15 dBVrms		
Flatness Relative to 1 kHz: CHANNEL 1					
Range Setting	AC Calibrator Amplitude	Signal Frequency	Measured Value	Lower Limit	Upper Limit
-11 dBVrms	0.28184 Vrms	49 kHz		-0.2 dB	0.2 dB
9 dBVrms	2.8184 Vrms	49 kHz		-0.2 dB	0.2 dB
27 dBVrms	22.387 Vrms	49 kHz		-0.2 dB	0.2 dB
9 dBVrms	2.8184 Vrms	99 kHz		-0.2 dB	0.2 dB
27 dBVrms	22.387 Vrms	99 kHz		-0.2 dB	0.2 dB

3. (continued)					
CHANNEL 2					
Range Setting	AC Calibrator Amplitude	Signal Frequency	Measured Value at 1 kHz dBVrms	Lower Limit	Upper Limit
-11 dBVrms	0.28184 Vrms	49 kHz		-0.2 dB	0.2 dB
9 dBVrms	2.8184 Vrms	49 kHz		-0.2 dB	0.2 dB
27 dBVrms	22.387 Vrms	49 kHz		-0.2 dB	0.2 dB

4. Amplitude Linearity

Linearity at 1 kHz, +27 dBV Range					
AC Calibrator Amplitude	Lower Limit	Upper Limit	Measured Value		
			Channel 1	Channel 2	
7.0795 mVrms	-72.32 dBVrms	-37.13 dBVrms			
35.481 mVrms	-31.01 dBVrms	-27.37 dBVrms			
0.17783 Vrms	-15.49 dBVrms	-14.53 dBVrms			
0.89125 Vrms	-1.217 dBVrms	-0.786 dBVrms			
4.4667 Vrms	12.84 dBVrms	13.16 dBVrms			
22.387 Vrms	26.85 dBVrms	27.15 dBVrms			

5. Amplitude and Phase Match

Frequency Span	Start Frequency	Range Setting	Measurement		Amplitude Limits
			Peak Amplitude	Minimum Amplitude	
6.4 kHz	80 Hz	-23 dBVrms			±0.4 dB
6.4 kHz	3.84 Hz	1 dBVrms			±0.4 dB
51.2 kHz	0 Hz	7 dBVrms			±0.4 dB

Measurement	Phase Limits	
	Peak Phase	Minimum Phase
		±1.0°
		±1.0°
		±1.8°

6. Anti-alias Filter Response

Signal Frequency	Alias Frequency	Measured Value		Specification
		Channel 1	Channel 2	
162.144 kHz	100 kHz			< -79 dBVrms
81.072 kHz	50 kHz			< -79 dBVrms

7. Frequency Accuracy			
Signal Frequency Hz	Lower Limit Hz	Upper Limit Hz	Measured Value
100 kHz	99.997 kHz	100.003 kHz	

8. Input Coupling Insertion Loss			
Channel 1 Insertion Loss dc - ac	Specification	Channel 2 Insertion Loss	Specification dc - ac
	<3 dB		<3 dB

9. Single Channel Phase Accuracy					
Relative to external trigger (TTL Level)					
Signal Frequency	Trigger Slope	Lower Limit	Upper Limit	Measured Value	
				Channel 1	Channel 2
10.24 kHz	Positive	-94 °	-86 °		
10.24 kHz	Negative	86 °	94 °		

10. Input Impedance					
Resistance Measurement:					
Range Setting	Lower Limit	Upper Limit	Measured Value		
			Channel 1	Channel 2	
27 dBVrms	0.900 MΩ	1.100 MΩ			
9 dBVrms	0.900 MΩ	1.100 MΩ			
-11 dBVrms	0.900 MΩ	1.100 MΩ			

Capacitance Measurement					
Channel 1					
V _{in}	=	Vrms			
V _c	=	Vrms			
Channel 1: 100 kHz					
$C = 15.9^{-12} \left(\frac{V_{in}}{V_c} - 2 \right)$					
Channel 1		Specification			
Measured Value =		pF	<100 pF		

10. (continued)

Channel 2

V_{in} = V_{rms}

V_c = V_{rms}

Channel 2: 50 kHz

$$C = 31.8^{-12} \left(\frac{V_{in}}{V_c} - 2 \right)$$

Channel 2 Specification

Measured Value = pF < 100 pF

11. Harmonic Distortion

Range: 1 dBVrms

Signal Frequency	Harmonic Frequency	Measured Value		Specification
		Channel 1	Channel 2	
24.96 kHz	49.92 kHz			< -69 dBVrms
16.64 kHz	49.92 kHz			< -69 dBVrms
49.92 kHz	99.84 kHz			< -69 dBVrms
33.28 kHz	99.84 kHz			< -69 dBVrms
24.96 kHz	99.84 kHz			< -69 dBVrms
19.97 kHz	99.84 kHz			< -69 dBVrms

12. Intermodulation Distortion

Input Amplitudes: -7 dBVrms (-6.02 dBfs)

Input Range: -1 dBVrms

Harmonic Frequency	Measured Value		Specification
	Channel 1	Channel 2	
20.25 kHz			< -71 dBVrms
30.50 kHz			< -71 dBVrms
1 kHz			< -71 dBVrms
50 kHz			< -71 dBVrms
10 kHz			< -71 dBVrms
79 kHz			< -71 dBVrms

13. Noise and Spurious Signal Level

Range: -51 dBVrms

Spurious Signals:

Start Frequency	Frequency Span	Measured Value		Specification
		Channel 1	Channel 2	
160 Hz	200 Hz			< -121 dBVrms
360 Hz	200 Hz			< -121 dBVrms
560 Hz	200 Hz			< -121 dBVrms
760 Hz	200 Hz			< -121 dBVrms
1.28 kHz	1.6 kHz			< -121 dBVrms
24 kHz	1.6 kHz			< -121 dBVrms
30 kHz	1.6 kHz			< -121 dBVrms
34.2 kHz	1.6 kHz			< -121 dBVrms
49 kHz	1.6 kHz			< -121 dBVrms
61 kHz	1.6 kHz			< -121 dBVrms
68 kHz	1.6 kHz			< -121 dBVrms
74 kHz	1.6 kHz			< -121 dBVrms
76 kHz	1.6 kHz			< -121 dBVrms
92 kHz	1.6 kHz			< -121 dBVrms
100 kHz	1.6 kHz			< -121 dBVrms

Noise Level:

Range: -51 dBVrms

Start Frequency	Frequency Span	Measured Value		Specification
		Channel 1	Channel 2	
160 Hz	12.8 kHz			< -130 dBV $\sqrt{\text{Hz}}$
1.28 kHz	50 kHz			< -140 dBV $\sqrt{\text{Hz}}$
1.28 kHz	100 kHz			< -140 dBV $\sqrt{\text{Hz}}$

14. Cross Talk

Measurement	Measured Value	Specification
Channel 2 - to - Channel 1		< -121 dBVrms
Channel 1 - to - Channel 2		< -121 dBVrms
Source - to - Input		< -121 dBVrms

15. Source Residual Offset

Source Level Vpk	Lower Limit	Upper Limit	Measured Value
0.00125V	-8.075 mV	8.075 mV	
5V	-308.0 mV	308.0 mV	

16. Source Amplitude Accuracy and Flatness

Amplitude Accuracy at 1 kHz:

Source Level Vpk	Range Setting Vpk	Lower Limit Vpk	Upper Limit Vpk	Source Amplitude Measured Value
0.1V	0.1V	96.0 mV	104 mV	
3V	3V	2.88V	3.12V	
5V	5V	4.8V	5.2V	

Flatness Relative to 1 kHz:

Signal Frequency	Measured Relative Value dB	Amplitude Limits
1 kHz		
10 kHz		±1 dB
50 kHz		±1 dB
99 kHz		±1 dB

17. Source Output Distortion

Source Frequency	Peak Distortion Value	Specification
10 kHz		< -60 dBc
100 kHz		< -40 dBc

18. Source Output Resistance

R1 =
 V1 = Vrms
 V2 = Vrms

$$R_s = R1 \left(\frac{V2 - V1}{V1} \right)$$

Measured Value = Ω Specification < 5 Ω

1. Self Test

Operation Verification – Yes

For this test, the Operation Verification Test and Performance Test are the same.

The self test checks the measurement hardware in the HP 35660A. No performance tests should be attempted until the analyzer passes this test. The self test takes approximately one minute to complete, and requires no external equipment.

Procedure

NOTE All tests must be performed with Automatic Calibration ON. When the instrument powers up, AUTOCAL is ON, do not turn it off.

1. Press the HP 35660A keys as follows:

```
< Preset >  
< Special Fctn >  
  [ SELF TEST ]  
  [ TEST LOG ]  
  [ RETURN ]  
  [ CLEAR TEST LOG ]  
  [ LONG CONF TEST ]  
  [ START ]
```

2. When the self test finished, check that all the tests have passed. Enter results on the test record.

If This Test Fails

If this test fails, contact your local Hewlett-Packard sales and service office or have a qualified service technician see the following sections in the *HP 35660A Service Manual*:

Section VII – Service: Assembly Level

2. DC Response

Operation Verification – Yes

For this test, the Operation Verification Test and Performance Test are the same.

This test measures the level of residual dc offset generated within the HP 35660A.

Procedure

NOTE All tests must be performed with Automatic Calibration ON. When the instrument powers up, AUTOCAL is ON, do not turn it off.

1. Connect the test equipment as shown in the following illustration. For specific information about required test equipment see Table 3-3.

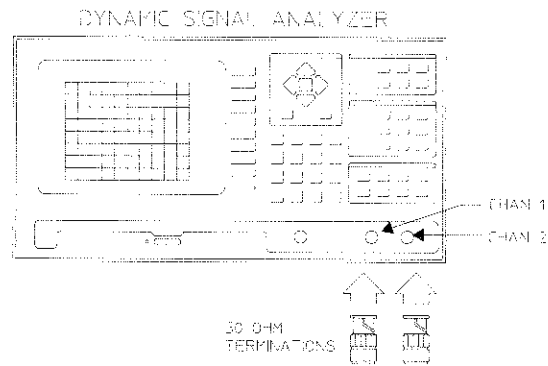

2. Press the HP 35660A keys as follows:

< Preset >
 < Format >
 [UPPER/LOWER]
 < Meas Type >
 [2 CHANNEL 51.2 kHz]
 < Input >
 [CHANNEL 1 SETUP] [AC/DC] [RETURN]
 [CHANNEL 2 SETUP] [AC/DC]
 < Freq >
 [SPAN] < 3 > < . > < 2 > [kHz]
 < Average >
 [AVERAGE **ON/OFF**] [NUMBER AVERAGES] < 2 > [ENTER]
 [FAST AVG **ON/OFF**]
 < Active Trace > (this activates trace B)
 < Meas Data >
 [SPECTRUM CHANNEL 2]
 < Active Trace > (this activates trace A)

3. For each of the range settings listed below, perform steps a through c:

Range Setting
-51 dBVrms
-35 dBVrms

a. Press the HP 35660A keys as follows:

< Input >
 [CHANNEL 1 RANGE] (to range setting in table)
 [CHANNEL 2 RANGE] (to range setting in table)
 < Start >
 < Marker >
 [COUPLED **ON/OFF**] [X ENTRY] < 0 > [Hz]

- b. Record the "A Marker Y:" reading on the test record for the channel 1 measured value.
- c. Record the "B Marker Y:" reading on the test record for the channel 2 measured value.

If This Test Fails

If this test fails, contact your local Hewlett-Packard sales and service office or have a qualified service technician see the following sections in the *HP 35660A Service Manual*:

Section III – Adjustments

DC Input Offset Adjustment

ADC Offset and Reference Adjustment

Section VII – Service:Assembly Level

One or more of the following is the most likely cause of the analyzer's failure:

A3 Input 1

A4 Input 2/ADC

3. Amplitude Accuracy and Flatness

Operation Verification – Yes

Differences between the Performance Test and the Operation Verification Test are noted in the shaded boxes.

This test determines amplitude accuracy and flatness for both channels of the HP 35660A. Using a frequency synthesizer and ac calibrator, a signal with an exact amplitude is input to both channels and measured. The amplitude of each channel is then compared to specifications.

Procedure

NOTE All tests must be performed with Automatic Calibration ON. When the instrument powers up, AUTOCAL is ON, do not turn it off.

1. Connect the test equipment as shown in the following illustration. For specific information about required test equipment see Table 3-3.

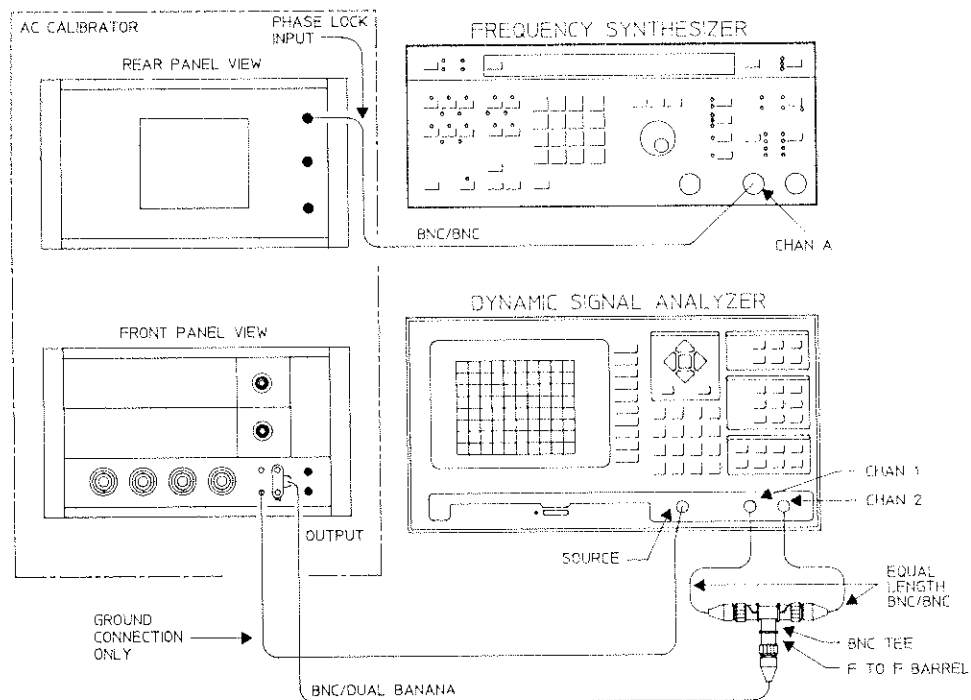

2. Configure the frequency synthesizer and the ac calibrator as follows:

Frequency Synthesizer

Mode2 Channel
FunctionSine Wave
Frequency (Chan A)1 kHz
Amplitude (Chan A)0.5 Vrms
Phase0 °
dc Offset0V
ModulationOFF
SweepOFF

AC Callibrator:

Frequency1 kHz
Amplitude2.8184 mVrms
VoltageOFF
Error%
Vernier0
ModeOPER
ControlLOCAL
Phase LockON
SenseINTERNAL

3. Press the HP 35660A keys as follows:

< Preset >
< Format >
 [UPPER/LOWER]
< Meas Type >
 [2 CHANNEL 51.2 kHz]
< Active Trace >(this activates trace B)
< Meas Data >
 [SPECTRUM CHANNEL 2]
< Active Trace >(this activates trace A)
< Freq >
 [SPAN] < 1 > < . > < 6 > [kHz]
 [CENTER] < 1 > [kHz]
< Input >
 [CHANNEL 1 SETUP] [AC/DC]
 [RETURN]
 [CHANNEL 2 SETUP] [AC/DC]
< Average >
 [AVERAGE **ON**/OFF]
 [NUMBER AVERAGES] < 4 > [ENTER]
 [FAST AVG **ON**/OFF]
< Marker >
 [COUPLED ON]

4. For each of the range settings listed below, perform steps a through e:

Use for Operation Verification

Range Setting	AC Calibrator Amplitude
-51 dBVrms	2.8184 mVrms
-27 dBVrms	44.668 mVrms
-11 dBVrms	0.28184 Vrms
9 dBVrms	2.8184 Vrms
27 dBVrms	22.387 Vrms

Use for Performance Test

Range Setting	AC Calibrator Amplitude
-51 dBVrms	2.8184 mVrms
-43 dBVrms	7.0795 mVrms
-35 dBVrms	17.783 mVrms
-27 dBVrms	44.668 mVrms
-11 dBVrms	0.28184 Vrms
1 dBVrms	1.1220 Vrms
9 dBVrms	2.8184 Vrms
19 dBVrms	8.9125 Vrms
27 dBVrms	22.387 Vrms

- a. Press the HP 35660A keys as follows:

< Input >
 [CHANNEL 1 RANGE] (to range setting in table)
 [CHANNEL 2 RANGE] (to range setting in table)

< Marker >
 [MARKER TO PEAK]

- b. Set the ac calibrator to the amplitude in the table.

- c. Press the HP 35660A keys as follows:

< Start >
 < Scale >
 [AUTO SCALE]
 < Active Trace > (this activates trace B)
 [AUTO SCALE]

- d. Record the "A Marker Y:" reading on the test record for the channel 1 measured value.
- e. Record the "B Marker Y:" reading on the test record for the channel 2 measured value.

5. Amplitude flatness is measured at several frequencies relative to 1 kHz. For each range listed below, perform steps a through m:

Measurement Type	Range Setting	Signal Frequency	AC Calibrator Amplitude
2 CHANNEL	-11 dBVrms	49 kHz	0.28184 Vrms
2 CHANNEL	9 dBVrms	49 kHz	2.8184 Vrms
2 CHANNEL	27 dBVrms	49 kHz	22.387 Vrms
1 CHANNEL	9 dBVrms	99 kHz	2.8184 Vrms
1 CHANNEL	27 dBVrms	99 kHz	22.387 Vrms

- a. Set the ac calibrator to 1kHz, amplitude 0.28184Vrms
- b. Set the frequency synthesizer to 1 kHz
- c. Press the HP 35660A keys as follows:
 - < Meas Type > (to measurement type in table)
 - < Input >
 - [CHANNEL 1 RANGE] (to range setting in table)
 - [CHANNEL 2 RANGE] (to range setting in table)
 - < Freq >
 - [CENTER] < 1 > [kHz]
- d. Set the ac calibrator to the amplitude in the table.
- e. Press the HP 35660A keys as follows:
 - < Start >
 - < Marker >
 - [MARKER TO PEAK][OFFSET]
 - [OFFSET ON][OFFSET ZERO]
 - < Active Trace >
 - [OFFSET ON]
 - [OFFSET ZERO]
- f. Set the ac calibrator to the signal frequency in the table.
- g. Set the frequency synthesizer to the signal frequency in the table.
- h. Press the HP 35660A keys as follows:
 - < Freq >
 - [Center] (to signal frequency in table)
 - < Start >
 - < Marker >
 - [MARKER TO PEAK]

- i. Record the “A Offset Y:” reading on the test record for the channel 1 measured value.
- j. When a two channel measurement is done, record the “B OffsetY:” reading on the test record for the channel 2 measured value.

If This Test Fails

If this test fails, contact your local Hewlett-Packard sales and service office or have a qualified service technician see the following sections in the *HP 35660A Service Manual*:

Section III – Adjustments

- Second Pass Gain Adjustment
- ADC Offset and Reference Adjustment
- Filters Flatness Adjustment
- Common Mode Rejection Adjustment

Section VII – Service: Assembly Level

One or more of the following is the most likely cause of the analyzer's failure:

- A3 Input 1
- A4 Input 2/ADC

4. Amplitude Linearity

Operation Verification Test – No

Do not perform this test for Operation Verification.

This test determines the amplitude linearity for both channels of the HP 35660A. Using a frequency synthesizer and ac calibrator, a signal with an exact amplitude is input into both channels and measured. The amplitude measured is then compared to specifications.

Procedure

NOTE All tests must be performed with Automatic Calibration ON. When the instrument powers up, AUTOCAL is ON, do not turn it off.

1. Connect the test equipment as shown in the following illustration. For specific information about required test equipment see Table 3-3.

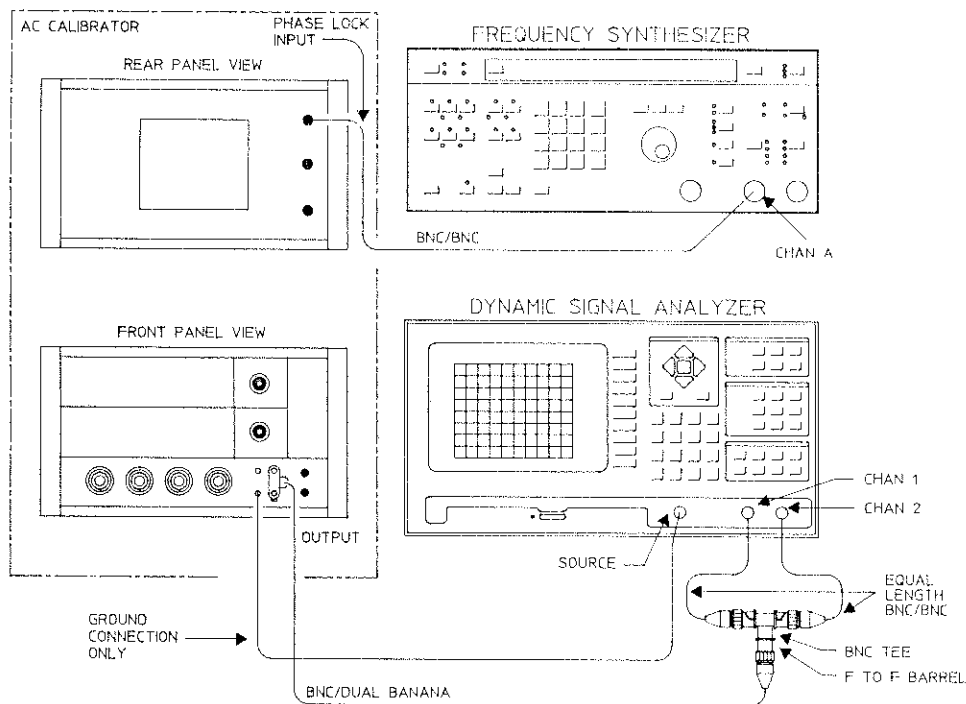

2. Configure the frequency synthesizer and the ac calibrator as follows:

Frequency Synthesizer:

Mode 2 Channel
Function Sine Wave
Frequency (Chan A) 1 kHz
Amplitude (Chan A) 0.5 Vrms
Phase 0°
dc Offset 0V
Modulation OFF
Sweep OFF

AC Calibrator:

Control LOCAL
Phase Lock ON
Sense INTERNAL
Mode OPER
Frequency 1 kHz
Amplitude 7.0795 mVrms

3. Press the HP 35660A keys as follows:

< Preset >
< Format >
 [UPPER/LOWER]
< Meas Type >
 [2 CHANNEL 51.2 kHz]
< Active Trace >(this activates trace B)
< Meas Data >
 [SPECTRUM CHANNEL 2]
< Active Trace >(this activates trace A)
< Freq >
 [SPAN] < 1 > < . > < 6 > [kHz]
 [CENTER] < 1 > [kHz]
< Marker >
 [COUPLED **ON**/OFF] < 1 > [kHz]
< Average >
 [AVERAGE **ON**/OFF] [NUMBER AVERAGES] < 4 > [ENTER]
 [FAST AVG **ON**/OFF]
< Input >
 [CHANNEL 1 RANGE] < 2 > < 7 > [dBVrms]
 [CHANNEL 1 SETUP] [AC/DC] [RETURN]
 [CHANNEL 2 RANGE] < 2 > < 7 > [dBVrms]
 [CHANNEL 2 SETUP] [AC/DC] [RETURN]

4. For each of the calibrator amplitude settings listed, perform steps a through d:

AC Calibrator amplitude
7.0795 mVrms
35.481 mVrms
0.17783 Vrms
0.89125 Vrms
4.4667 Vrms
22.387 Vrms

- a. Set the ac Calibrator to the amplitude in the table.
- b. Press < Start > on the HP35660A.
- c. Record the "A Marker Y:" reading on the test record for the channel 1 measured value.
- d. Record the "B Marker Y:" reading on the test record for the channel 2 measured value.

If This Test Fails

If this test fails, contact your local Hewlett-Packard sales and service office or have a qualified service technician see the following sections in the *HP 35660A Service Manual*:

Section III – Adjustments

- Second Pass Gain Adjustment
- ADC Offset and Reference Adjustment
- Filters Flatness Adjustment
- Common Mode Rejection adjustment

Section VII – Service: Assembly Level

One or more of the following is the most likely cause of the analyzer's failure:

- A3 Input 1
- A4 Input 2/ADC

5. Amplitude and Phase Match

Operation Verification – Yes

For this test, the Operation Verification Test is the same as the Performance Test.

This test measures the amplitude and phase between channels 1 and 2. An identical signal is input to both channels (using the HP 35660A's source), and measured to verify that the amplitude and phase are approximately the same for both channels.

Procedure

NOTE All tests must be performed with Automatic Calibration ON. When the instrument powers up, AUTOCAL is ON, do not turn it off.

1. Connect the test equipment as shown in the following illustration. The cables to channel 1 and channel 2 must be equal length. For specific information about required test equipment see Table 3-3.

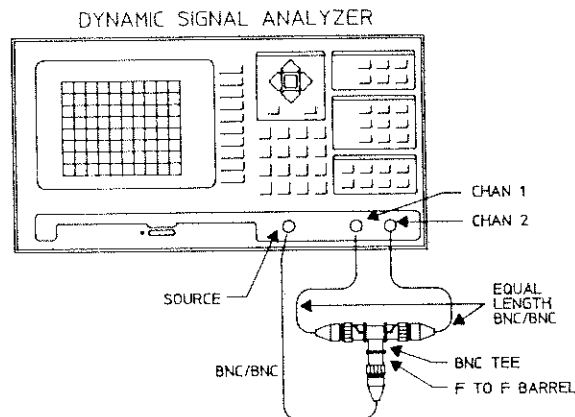

2. Press the HP 35660A keys as follows:

< Preset >
 < Format >
 [UPPER/LOWER]
 < Meas Type >
 [2 CHANNEL 51.2 kHz]
 < Window >
 [UNIFORM]
 < Input >
 [CHANNEL 1 SETUP] [AC/DC] [RETURN]
 [CHANNEL 2 SETUP] [AC/DC]
 < Average >
 [AVERAGE **ON**/OFF] [NUMBER AVERAGES] < 1 > < 6 > [ENTER]
 [FAST AVG **ON**/OFF]
 < Source >
 [SOURCE **ON**/OFF] [PERIODIC CHIRP]
 < Trigger >
 [SOURCE TRIGGER]
 < Meas Data >
 [FREQUENCY RESPONSE]
 < Scale >
 [CENTER REFERENCE] < 0 > [dB]
 < Active Trace > (this activates trace B)
 < Meas Data >
 [FREQUENCY RESPONSE]
 < Trace Type >
 [PHASE]
 < Active Trace > (this activates trace A)

3. For each of the frequency settings shown, perform steps a through h to measure the amplitude match:

Frequency Span	Start Frequency	Range Setting	Source Level
6.4 kHz	80 Hz	-23 dBVrms	-23 dBVrms
6.4 kHz	3.84 Hz	1 dBVrms	1 dBVrms
51.2 kHz	0 Hz	7 dBVrms	7 dBVrms

- a. Press the HP 35660A keys as follows:
 - < Freq >
 - [SPAN] (to frequency span in table)
 - [START] (to start frequency in table)
 - < Input >
 - [CHANNEL 1 RANGE] (to range setting in table)
 - [CHANNEL 2 RANGE] (to range setting in table)
 - < Source >
 - [LEVEL] (to source level in table)
 - < Start >
 - When the average is complete press:
 - < Marker >
 - [MARKER TO PEAK]
- b. Record the "A Marker Y:" reading on the test record as the peak amplitude measurement.
- c. Press the HP 35660A keys as follows:
 - < Marker >
 - [MARKER TO MINIMUM]
- d. Record the "A Marker Y:" reading on the test record for the minimum amplitude measurement.
- e. Press the HP 35660A keys as follows:
 - < Active Trace >(this activates trace B)
 - < Marker >
 - [MARKER TO PEAK]
- f. Record the "B Marker Y:" reading on the test record as the peak phase measurement.
- g. Press the HP 35660A keys as follows:
 - < Marker >
 - [MARKER TO MINIMUM]
 - < Active Trace >(this activates trace A)
- h. Record the "B Marker Y:" reading on the test record as the minimum phase measurement.

If This Test Fails

If this test fails, contact your local Hewlett-Packard sales and service office or have a qualified service technician see the following sections in the *HP 35660A Service Manual*:

Section III — Adjustments

- Second pass Gain Adjustment
- ADC Offset and Reference Adjustment
- Filters Flatness
- Common Mode Rejection Adjustment

Section VII — Service: Assembly Level

One or more of the following is the most likely cause of the analyzer's failure:

- A3 Input 1
- A4 Input 2/ADC
- A1 Digital Processor

6. Anti-Alias Filter Response

Operation Verification Test – No

Do not perform this Test for Operation Verification.

This test measures the ability of the 50 kHz and 100 kHz low pass anti-alias filters to reject frequencies caused by aliasing. Alias frequencies occur when the difference of the input signal frequency and the HP 35660A's sample rate both fall within the frequency range of interest. Using a frequency synthesizer, a signal known to cause an alias frequency is input to the HP 35660A. The HP 35660A then measures the alias frequency to determine how well the alias frequency was rejected.

Procedure

NOTE All tests must be performed with Automatic Calibration ON. When the instrument powers up, AUTOCAL is ON, do not turn it off.

NOTE The HP 35660A may produce some spurious signals in the 0 to 100 kHz span. Ignore signals at frequencies other than those listed in the table when performing this test.

1. Connect the test equipment as shown in the following illustration. For specific information about required test equipment see Table 3-3.

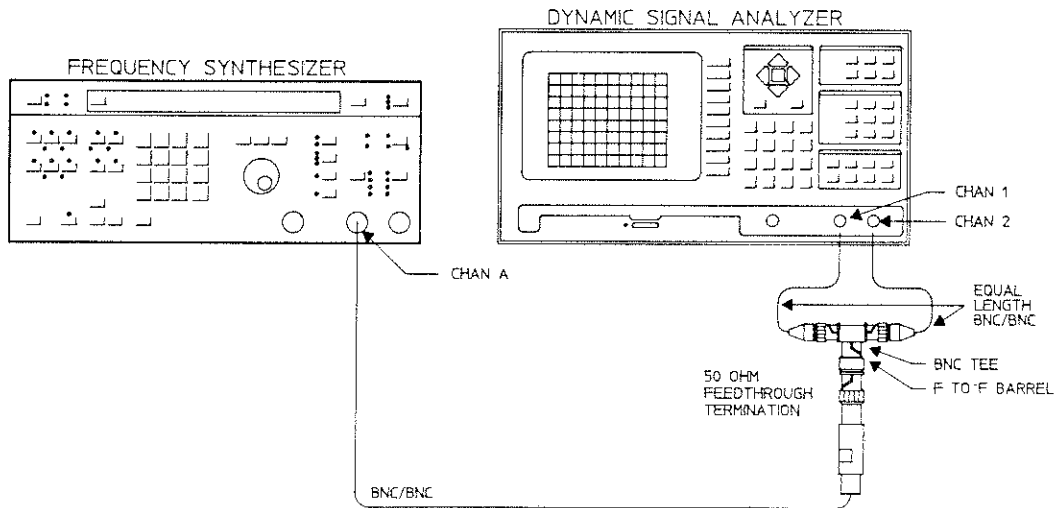

2. Configure the instruments as follows:

Frequency Synthesizer:

Mode	2 Channel
Function	SINE WAVE
Frequency (Chan A)	80 kHz
Amplitude (Chan A)	354.8 mVrms
Phase	0
dc Offset	0V
Modulation	OFF
Sweep	OFF

3. Press the HP 35660A keys as follows:

```

< Preset >
< Format >
  [ UPPER/LOWER ]
< Input >
  [ CHANNEL 1 RANGE ] < ±9 > [ dBVrms ]
  [ CHANNEL 1 SETUP ] [ AC/DC ] [ RETURN ]
  [ CHANNEL 2 RANGE ] < ±9 > [ dBVrms ]
  [ CHANNEL 2 SETUP ] [ AC/DC ]
< Window >
  [ HANNING ]
< Freq >
  [ SPAN ] < 1 > < . > < 6 > [ kHz ]
  [ CENTER ] < 8 > < 0 > [ kHz ]
< Marker >
  [ MARKER TO PEAK ]

```

4. Adjust the amplitude of the frequency synthesizer until the Y marker reads -9 ± 0.1 dBVrms.
5. Set the frequency synthesizer to 162.144 kHz.
6. Press the HP35660A keys as follows:

```

< Average >
  [ AVERAGE ON/OFF ]
  [ NUMBER AVERAGES ] < 1 > < 6 >
  [ ENTER ]
  [ FAST AVG ON/OFF ]
< Freq >
  [ START ] < 9 > < 9 > [ kHz ]
< Start >
< Scale >
  [ AUTO SCALE ]
< Marker >
  < 1 > < 0 > < 0 > [ kHz ]

```

7. Record the "A Marker Y:" reading on the test record for the channel measured value at 100 kHz.
8. Set the frequency synthesizer to 81.072 kHz.

9. Press the HP35660A keys as follows:

< Freq >
[CENTER] < 5 > < 0 > [kHz]

< Meas type >
[2 CHANNEL 51.2kHz]

< Active Trace >(this activates trace B)

< Meas Data >
[SPECTRUM CHANNEL 2]

< Active Trace >(this activates trace A)

< Start >(Wait until measurement is finished before proceeding)

< Scale >
[AUTO SCALE]

< Active Trace >(this activates trace B)

< Scale >
[AUTO SCALE]

< Marker >
[COUPLED **ON**/OFF] < 5 > < 0 > [kHz]

10. Record the “A Marker Y:” reading on the test record for the channel 1 measured value at 50 kHz.

11. Record the “B Marker Y:” reading on the test record for the channel 2 measured value at 50 kHz.

If This Test Fails

If this test fails, contact your local Hewlett-Packard sales and service office or have a qualified service technician see the following sections in the *HP 35660A Service Manual*:

Section III – Adjustments
Filters Flatness Adjustment

Section VII – Service: Assembly Level
One or more of the following is the most likely cause of the analyzer’s failure:

A3 Input 1
A4 Input 2/ADC

7. Frequency Accuracy

Operation Verification – Yes

For this test, the Operation Verification Test is the same as the Performance Test.

This test uses a frequency synthesizer to measure the frequency accuracy of the HP 35660A.

Procedure

NOTE All tests must be performed with Automatic Calibration ON. When the instrument powers up, AUTOCAL is ON, do not turn it off.

1. Connect the test equipment as shown in the following illustration. For specific information about required test equipment see Table 3-3.

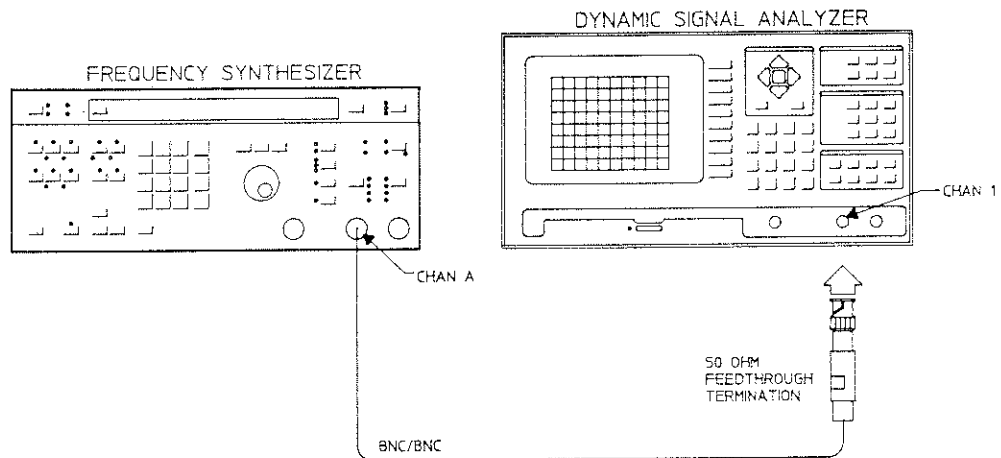

2. Configure the instruments as follows:

Frequency Synthesizer:

Mode 2 Channel
Function Sine Wave
Frequency (Chan A) 100 kHz
Amplitude (Chan A) 1 Vrms
Phase 0 °
dc Offset 0V
Modulation OFF
Sweep OFF

3. Press the HP 35660A keys as follows:

< Preset >
< Input >
 [CHANNEL 1 RANGE] < 1 > [dBVrms]
 [CHANNEL 1 SETUP] [AC/DC] [RETURN]
< Freq >
 [SPAN] < 1 > < 0 > < 0 > [Hz]
 [CENTER] < 1 > < 0 > < 0 > [kHz]
< Window >
 [HANNING]
< Average >
 [AVERAGE **ON**/OFF] [NUMBER AVERAGES] < 2 > [ENTER]
 [FAST AVG **ON**/OFF]
< Start >
 When the measurement is finished,

4. Press the HP 35660A keys as follows:

< Marker >
 [MARKER TO PEAK]

5. Record the X marker reading as the measured value on the performance test record.

If This Test Fails

If this test fails, contact your local Hewlett-Packard sales and service office or have a qualified service technician see the following sections in the *HP 35660A Service Manual*:

Section III – Adjustments
Frequency Reference Adjustment

Section VII – Service: Assembly Level
One or more of the following is the most likely cause of the analyzer's failure:

A1 Digital Processor

8. Input Coupling Insertion Loss

Operation Verification Test – No

Do not perform this test for Operation Verification.

This test measures the input coupling insertion loss (caused by ac coupling capacitors) of the HP 35660A. The amplitude of a 1 Hz signal is measured in both ac and dc coupled modes and the values are used to determine insertion loss.

Procedure

NOTE All tests must be performed with Automatic Calibration ON. When the instrument powers up, AUTOCAL is ON, do not turn it off.

1. Connect the test equipment as shown in the following illustration. For specific information about required test equipment see Table 3-3.

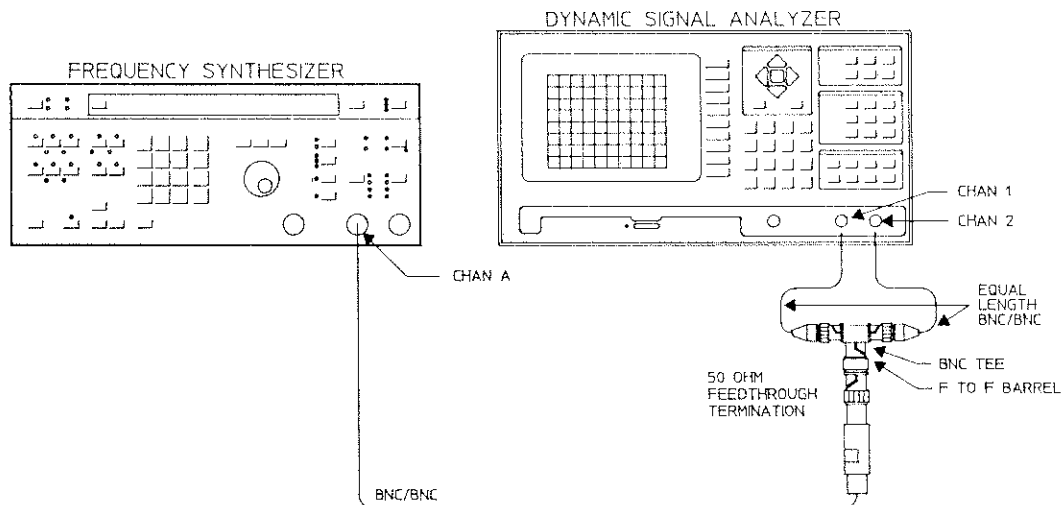

2. Configure the instruments as follows:

Frequency Synthesizer:

Mode2 Channel
FunctionSine Wave
Frequency (Chan A)1 Hz
Amplitude (Chan A)1 Vrms
Phase0°
dc Offset0V
ModulationOFF
SweepOFF

3. Press the HP 35660A keys as follows:

< Preset >
< Format >
 [UPPER/LOWER]
< Meas Type >
 [2 CHANNEL 51.2 kHz]
< Window >
 [HANNING]
< Input >
 [CHANNEL 1 RANGE] < 1 > [dBVrms]
 [CHANNEL 1 SETUP] [AC/DC] [RETURN]
 [CHANNEL 2 RANGE] < 1 > [dBVrms]
 [CHANNEL 2 SETUP] [AC/DC] [RETURN]
< Freq >
 [SPAN] < 1 > < 0 > < 0 > [Hz]
< Average >
 [AVERAGE **ON**/OFF] [NUMBER AVERAGES] < 4 > [ENTER]
 [FAST AVG **ON**/OFF]
< Active Trace > (this activates trace B)
< Meas Data >
 [SPECTRUM CHANNEL 2]
< Start >
< Scale >
 [AUTO SCALE]
< Active Trace > (this activates trace A)
< Scale >
 [AUTO SCALE]
< Marker >
 [COUPLED **ON**/OFF] < 1 > [Hz]

4. Measure the relative value between ac and dc coupling for channel 1 and 2 by performing step a through d:
 - a. When the measurement is finished, press the HP 35660A keys as follows:

```
< Marker >  
  [ OFFSET ]  
  [ OFFSET ON ][ OFFSET ZERO ]  
  
< Active Trace > ( this activates trace B )  
  [ OFFSET ON ][ OFFSET ZERO ]
```
 - b. Press the HP 35660A keys as follows:

```
< Input >  
  [ CHANNEL 1 SETUP ] [ AC/DC ] [ RETURN ]  
  [ CHANNEL 2 SETUP ] [ AC/DC ]  
  
< Start >
```
 - c. When the measurement is finished, record the "A Marker Y:" reading on the test record for channel 1, Insertion Loss.
 - d. Record the "B Marker Y:" reading on the test record for channel 2, Insertion Loss.

If This Test Fails

If this test fails, contact your local Hewlett-Packard sales and service office or have a qualified service technician see the following sections in the *HP 35660A Service Manual*:

Section III — Adjustments

None

Section VII — Service: Assembly Level

One or more of the following is the most likely cause of the analyzer's failure:

A3 Input 1

A4 Input 2/ADC

9. Single Channel Phase Accuracy

Operation Verification – Yes

For this test, the Operation Verification Test is the same as the Performance Test.

This test measures the phase accuracy of the HP 35660A relative to the phase of a trigger signal. Using a frequency synthesizer, an identical square wave is applied to both channels and a synchronized TTL level signal to the trigger input. The phase between the trigger and each channel is then measured and compared to specification.

Procedure

NOTE All tests must be performed with Automatic Calibration ON. When the instrument powers up, AUTOCAL is ON, do not turn it off.

1. Connect the test equipment as shown in the following illustration. For specific information about required test equipment see Table 3-3.

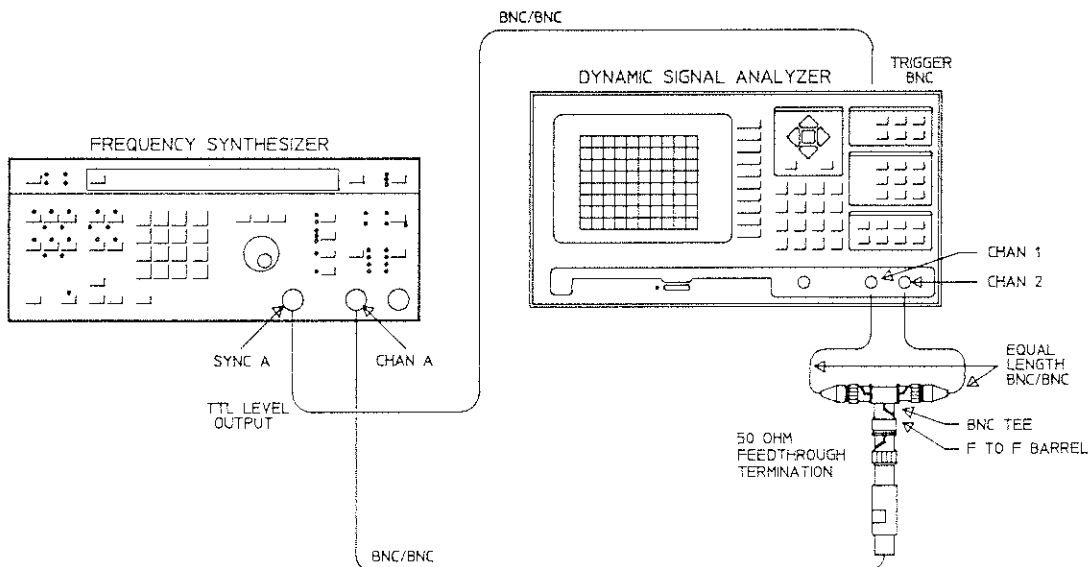

2. Configure the frequency synthesizer as follows:

Frequency Synthesizer:

Mode 2 Channel
Function Square Wave
Frequency (Chan A) 10.24 kHz
Amplitude (Chan A) 1.122 Vrms
Phase 0°
dc Offset 0Vdc
Modulation OFF
Sweep OFF

3. Press the HP 35660A keys as follows:

< Preset >
< Format >
 [UPPER/LOWER]
< Window >
 [UNIFORM]
< Meas Type >
 [2 CHANNEL 51.2 kHz]
< Freq >
 [SPAN] < 1 > < . > < 6 > [kHz]
 [CENTER] < 1 > < 0 > < . > < 2 > < 4 > [kHz]
< Input >
 [CHANNEL 1 RANGE] < 1 > [dBVrms]
 [CHANNEL 1 SETUP] [AC/DC] [RETURN]
 [CHANNEL 2 RANGE] < 1 > [dBVrms]
 [CHANNEL 2 SETUP] [AC/DC]
< Trigger >
 [EXTERNAL TRIGGER]
< Average >
 [AVERAGE **ON**/OFF] [NUMBER AVERAGES] < 1 > < 6 > [ENTER]
 [FAST AVG **ON**/OFF] [VECTOR AVERAGE]
< Trace Type >
 [PHASE]
< Active Trace > (this activates trace B)
< Meas Data >
 [SPECTRUM CHANNEL 2]
< Trace Type >
 [PHASE]

< Marker >
[COUPLED **ON**/OFF]
< Active Trace >(this activates trace A)
< Marker >
[X ENTRY] < 1 > < 0 > < . > < 2 > < 4 > [kHz]

4. For each trigger slope listed below, perform steps a through d:

Trigger Slope
Positive Negative

< Trigger >
[TRIGGER SET UP]
[SLOPE POS/NEG] (to trigger slope in table)
< Start >

- c. Record the “A Marker Y:” reading on the test record for the channel 1 measured value.
d. Record the “B Marker Y:” reading on the test record for the channel 2 measured value.

If This Test Fails

If this test fails, contact your local Hewlett-Packard sales and service office or have a qualified service technician see the following sections in the *HP 35660A Service Manual*:

Section III – Adjustments
None

Section VII – Service: Assembly Level
One or more of the following is the most likely cause of the analyzer’s failure:

A1 Digital Processor
A3 Input 1
A4 Input 2/ADC

10. Input Impedance

Operation Verification Test – No

Do not perform this test for Operation Verification.

This test measures the input impedance for each channel of the HP 35660A. The input impedance appears as an input resistance and input capacitance. The input resistance is measured directly with a digital voltmeter. The input capacitance is determined using a frequency synthesizer, a digital voltmeter, and the formula in step 12.

NOTE An LCR meter (such as the HP 4261A or HP 4332A) can be used to measure the input capacitance directly.

Procedure

NOTE All tests must be performed with Automatic Calibration ON. When the instrument powers up, AUTOCAL is ON, do not turn it off.

1. Connect the test equipment as shown in the following illustration. For specific information about required test equipment see Table 3-3.

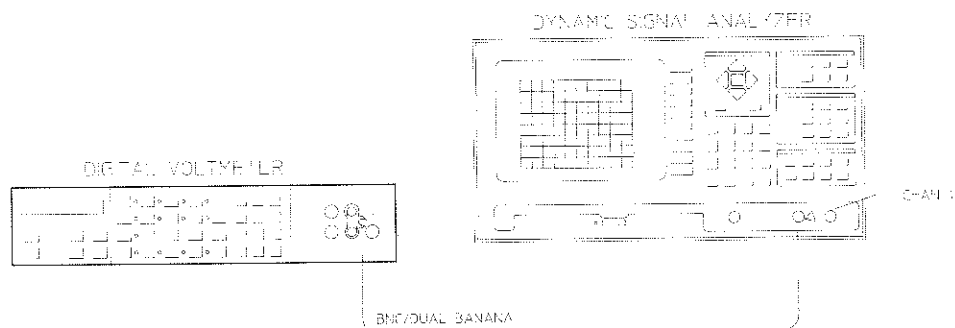

2. Configure the digital voltmeter as follows:

Digital Voltmeter

Function2 WIRE k Ω
RangeAUTO
TriggerINTERNAL
Sample RateMAXIMUM
High ResolutionON
Auto CalON

3. Press the HP 35660A keys as follows:

< Preset >
< Meas Type >
 [2 CHANNEL 51.2 kHz]
< Input >
 [CHANNEL 1 SETUP] [AC/DC] [RETURN]
 [CHANNEL 2 SETUP] [AC/DC]

4. For each of the following range settings, perform the following steps for channel 1. Record the digital voltmeter reading on the performance test record.

Range Setting
27 dBVrms
9 dBVrms
-11 dBVrms

Press the HP 35660A keys as follows:

< Input >
 [CHANNEL 1 RANGE] (to each range setting above)

- Change the BNC input connector to channel 2. For each of the following range settings, perform the following steps for channel 2. Record the digital voltmeter reading on the test record.

Range Setting
27 dBVrms
9 dBVrms
-11 dBVrms

Press the HP 35660A keys as follows:

< input >
[CHANNEL 2 RANGE] (to each range setting above)

- Connect the test instruments as shown below:

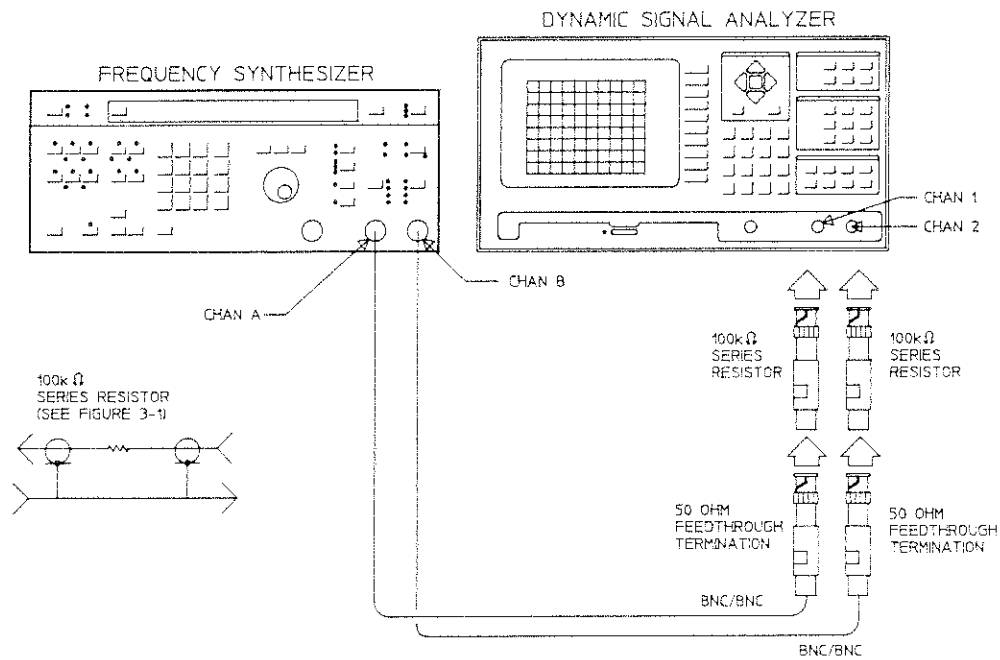

7. Set the frequency synthesizer as follows:

Frequency Synthesizer:

Mode2 Channel
 FunctionSine Wave
 Frequency (Chan A)100 kHz
 Amplitude (Chan A)1 Vrms
 Frequency (Chan B)50 kHz
 Amplitude (Chan B)1 Vrms
 Phase0 °
 dc Offset0 Vdc
 ModulationOFF
 SweepOFF

8. Perform the following steps:

- a. Press the HP 35660A keys as follows:

< Meas Type >
 [1 CHANNEL 102.4 kHz]
 < Format >
 [UPPER/LOWER]
 < Window >
 [FLATTOP]
 < Input >
 [CHANNEL 1 RANGE] < - > < 1 > < 3 > [dBVrms]
 < Freq >
 [SPAN] < 1 > < . > < 6 > [kHz]
 [CENTER] < 1 > < 0 > < 0 > [kHz]
 < Start >
 < Average >
 [AVERAGE **ON**/OFF] [NUMBER AVERAGES] < 1 > < 6 > [ENTER]
 [FAST AVG **ON**/OFF]
 < Trace Type >
 [LINEAR MAGNITUDE]
 < Scale >
 [VERTICAL UNIT] [Vrms] [AUTO SCALE]
 < Start >
 < Marker >
 < 1 > < 0 > < 0 > [kHz]

- b. Record the “A Marker Y:” amplitude reading (in Vrms) on the test record for channel 1 (in the Vc position).

9. Remove the 100 k Ω resistor from the channel 1 signal path and connect the BNC cable with the 50 Ω termination directly to the HP 35660A channel 1 input connector. Perform the following steps:

- a. Press the HP 35660A keys as follows:

```
< Input >  
  [ CHANNEL 1 RANGE ] < 1 > [ dBVrms ]  
< Start >
```

- b. Record the "A Marker Y:" amplitude reading (in Vrms) on the test record for channel 1 (in the Vin position).

10. Perform the following steps for the channel 2 measurement:

- a. Press the HP 35660A keys as follows:

```
< Meas Type >  
  [ 2 CHANNEL 51.2 kHz ]  
< Active Trace >(this activates trace B)  
< Meas Data >  
  [ SPECTRUM CHANNEL 2 ]  
< Input >  
  [ CHANNEL 2 RANGE ] < - > < 1 > < 3 > [ dBVrms ]  
< Freq >  
  [ SPAN ] < 1 > < . > < 6 > [ kHz ]  
  [ CENTER ] < 5 > < 0 > [ kHz ]  
< Trace Type >  
  [ LINEAR MAGNITUDE ]  
< Scale >  
  [ VERTICAL UNITS ] [ Vrms ] [ AUTO SCALE ]  
< Start >  
< Marker >  
  < 5 > < 0 > [ kHz ]
```

- b. Record the "B Marker Y:" amplitude reading (in Vrms) on the test record for channel 2 (Vc position).

11. Remove the 100 k Ω resistors from the channel 2 signal path and connect the BNC cable with the 50 Ω termination directly to the HP 35660A channel 2 input connector. Perform the following steps:

a. Press the HP 35660A keys as follows:

< Input >
[CHANNEL 2 RANGE] < 1 > [dBVrms]
< Start >

b. Record the “B Marker Y:” amplitude reading (in Vrms) on the test record for channel 2 (Vin position).

12. Use the following formulas to calculate the input capacitance:

Formulas:

Channel 1: 100 kHz

$$C = 15.9^{-12} \left(\frac{V_{in}}{V_c} - 2 \right)$$

Channel 2: 50 kHz

$$C = 31.8^{-12} \left(\frac{V_{in}}{V_c} - 2 \right)$$

If This Test Fails

If this test fails, contact your local Hewlett-Packard sales and service office or have a qualified service technician see the following sections in the *HP 35660A Service Manual*:

Section III – Adjustments

None

Section VII – Service: Assembly Level

One or more of the following is the most likely cause of the analyzer’s failure:

A3 Input 1

A4 Input 2/ADC

11. Harmonic Distortion

Operation Verification Test – No

Do not perform this test for Operation Verification.

This test measures the harmonic distortion generated in the HP 35660A.

Using a frequency synthesizer, selected frequencies which have a harmonic at 49 kHz (for channel 2) or 99 kHz (for channel 1) are input to the HP 35660A. The amplitude of the harmonic frequency is then measured and compared to specifications.

Procedure

NOTE All tests must be performed with Automatic Calibration ON. When the instrument powers up, AUTOCAL is ON, do not turn it off.

1. Connect the test equipment as shown in the following illustration. For specific information about required test equipment see Table 3-3.

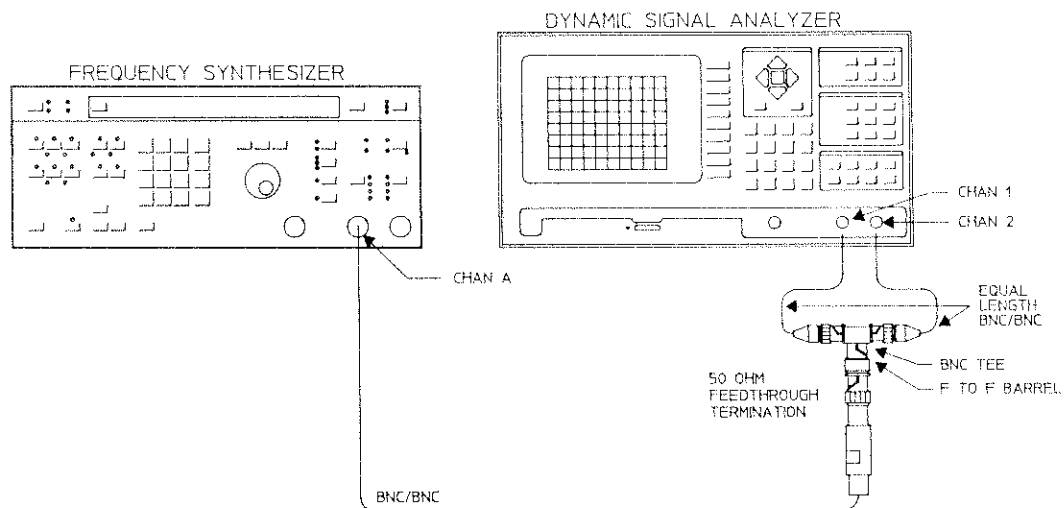

2. Configure the frequency synthesizer as follows:

Frequency Synthesizer

Mode2 Channel
 FunctionSINE WAVE
 Frequency (Chan A)24.96 kHz
 Amplitude (Chan A)1.12 Vrms
 Phase0
 dc Offset0 V
 ModulationOFF
 SweepOFF

NOTE This test requires a low distortion synthesizer with harmonic distortion ≤ -70 dBc.

3. Press the HP 35660A keys as follows:

< Preset >
 < Format >
 [UPPER/LOWER]
 < Meas Type >
 [2 CHANNEL 51.2 kHz]
 < Input >
 [CHANNEL 1 RANGE] < 1 > [dBVrms]
 [CHANNEL 2 RANGE] < 1 > [dBVrms]
 [CHANNEL 1 SETUP] [AC/DC] [RETURN]
 [CHANNEL 2 SETUP] [AC/DC]
 < Window >
 [HANNING]
 < Average >
 [NUMBER AVERAGES] < 4 > [ENTER]
 [FAST AVG ON/OFF]
 < Scale >
 [VERTICAL/DIV] < 1 > < 5 > [dB]
 < Active Trace > (this activates trace B)
 < Meas Data >
 [SPECTRUM CHANNEL 2]
 < Scale >
 [VERTICAL/DIV] < 1 > < 5 > [dB]
 < Active Trace > (this activates trace A)
 < Marker >
 [COUPLED ON/OFF]

4. For each of the two channel measurements listed below, perform steps a through f:

Measurement Type	Input Signal Frequency	Harmonic Number	Harmonic Frequency
2 CHANNEL	24.96 kHz	2nd	49.92 kHz
2 CHANNEL	16.64 kHz	3rd	49.92 kHz
1 CHANNEL	49.92 kHz	2nd	99.84 kHz
1 CHANNEL	33.28 kHz	3rd	99.84 kHz
1 CHANNEL	24.96 kHz	4th	99.84 kHz
1 CHANNEL	19.97 kHz	5th	99.84 kHz

- a. Set the frequency synthesizer to the input signal frequency in the table.
b. Press the HP 35660A keys as follows:

< Average >
[AVERAGE ON/OFF]
< Marker > [Marker to Peak]

- c. Adjust the amplitude of the frequency synthesizer until the Y Marker reading reads 1 ± 0.1 dBVrms.
d. Press the HP 35660A keys as follows:

< Average >
[AVERAGE ON/OFF]
< Start >
< Marker > (to harmonic frequency in table)

- e. Record the "A Marker Y:" amplitude reading on the test record as the harmonic frequency amplitude for channel 1.
Record the "B Marker Y:" amplitude reading on the test record as the harmonic frequency amplitude for channel 2.

5. Press the HP 35660A keys as follows:

< Meas Type >
[1 CHANNEL 102.4 kHz]
< Freq >
[FULL SPAN]

6. For each of the 1 CHANNEL measurements listed in the table in step 4, perform steps a through e:
 - a. Set the frequency synthesizer to the input signal frequency in the table.
 - b. Press the HP35660A keys as follows
 - < Average >
[AVERAGE ON/OFF]
 - < Marker > [Marker to Peak]
 - c. Adjust the amplitude of the frequency synthesizer until the y marker reading reads 1 ± 0.1
 - d. Press the HP 35660A keys as follows:
 - < Average >
[AVERAGE ON/OFF]
 - < Start >
 - < Marker > (to harmonic frequency in table)
 - e. Record the "A Marker Y:" amplitude reading on the test record as the harmonic frequency amplitude for channel 1.

If This Test Fails

If this test fails, contact your local Hewlett-Packard sales and service office or have a qualified service technician see the following sections in the *HP 35660A Service Manual*:

Section III – Adjustments
2nd Pass Gain Adjustment
ADC Offset and Reference Adjustment

Section VII – Service: Assembly Level
One or more of the following is the most likely cause of the analyzer's failure:

A3 Input 1
A4 Input 2/ADC

12. Intermodulation Distortion

Operation Verification Test – No

Do not perform this test for Operation Verification.

This test measures the level of intermodulation distortion products generated within the HP 35660A. This is done by mixing two signals to provide a modulated signal to the analyzer's input. Anytime two signals are mixed, the resultant signal includes the two fundamental frequencies plus their sum and difference frequencies (the sum and difference frequencies are the intermodulation products). The amplitude of each intermodulation product (which should be negligible) is measured with the HP 35660A to determine if it meets specifications.

Procedure

NOTE All tests must be performed with Automatic Calibration ON. When the instrument powers up, AUTOCAL is ON, do not turn it off.

1. Connect the test equipment as shown in the following illustration. For specific information about required test equipment see Table 3-3.

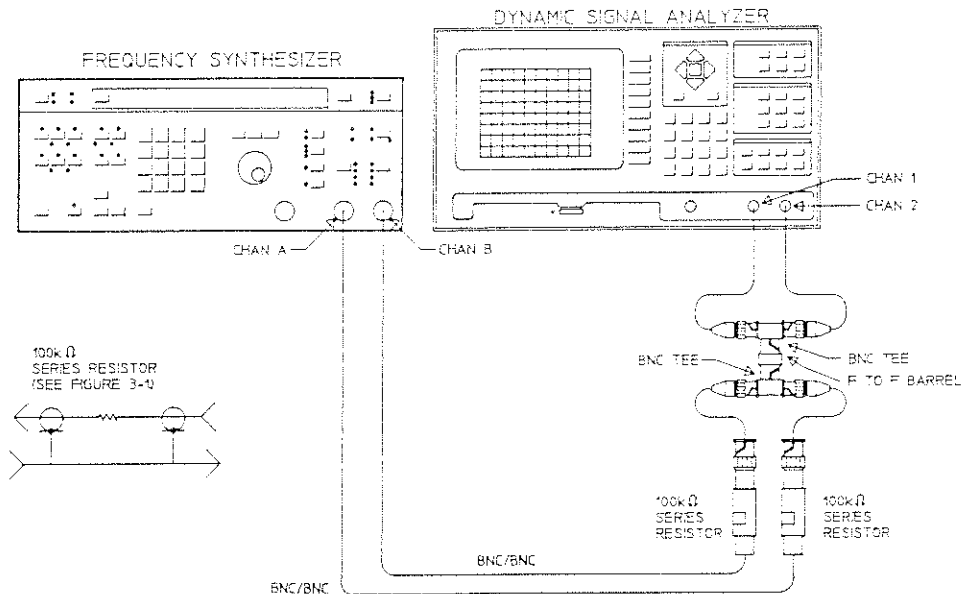

NOTE If the "COMBINED" mode is used on the HP3326A, use output from CHAN A with one 50Ω termination instead of the 100 kΩ series resistors.

2. Configure the frequency synthesizer as follows:

Frequency Synthesizer:

Mode Two-Tone
 Function SINE WAVE
 Frequency (Chan A) 10 kHz
 Amplitude (Chan A) 0.5 V_{rm}
 Frequency (Chan B) 10.25 kHz
 Amplitude (Chan B) 0.5 V_{rm}
 Phase 0
 dc Offset 0V
 Modulation OFF
 Sweep OFF

3. Press the HP 35660A keys as follows:

< Preset >
 < Format >
 [UPPER/LOWER]
 < Meas Type >
 [2 CHANNEL 51.2 kHz]
 < Input >
 [CHANNEL 1 RANGE] < -1 > [dBV_{rms}]
 [CHANNEL 1 SETUP] [AC/DC] [RETURN]
 [CHANNEL 2 RANGE] < -1 > [dBV_{rms}]
 [CHANNEL 2 SETUP] [AC/DC]
 < Window >
 [HANNING]
 < Freq >
 [SPAN] < 8 > < 0 > < 0 > [Hz]
 < Scale >
 [VERTICAL/DIV] < 1 > < 5 > [dB]
 < Active Trace > (this activates trace B)
 < Meas Data >
 [SPECTRUM CHANNEL 2]
 < Scale >
 [VERTICAL/DIV] < 1 > < 5 > [dB]
 < Active Trace > (this activates trace A)
 < Marker >
 [COUPLED **ON**/OFF]
 < Average >
 [NUMBER AVERAGES] < 1 > < 6 > [ENTER]
 [FAST AVG **ON**/OFF]

4. For the 2 Channel measurements listed below, perform steps a through f:

- a. Set the frequency synthesizer to the Input Signals F1 and F2 as follows:

Measurement Type	Input Signals		Intermodulation Frequency
	F1	F2	
2 CHANNEL	10 kHz	10.25 kHz	20.25 kHz 30.50 kHz

- b. Press the HP35660A keys as follows:

< Average >
[AVERAGE ON/OFF]
< Freq >
[CENTER] (to the F1 frequency in table "Input Signals")
< Marker > (to the F1 frequency in table "Input Signals")

- c. Adjust the amplitude of the synthesizer's channel A until "A Marker Y:" and "B Marker Y:" equals -7 ± 0.100 dBVrms.

- d. Press the HP35660A keys as follows:

< Freq >
[CENTER] (to the F2 frequency in table "Input Signals")
< Marker > (to the F2 frequency in table "Input Signals")

- e. Adjust the amplitude of the synthesizer's channel B until "A Marker Y:" and "B Marker Y:" equals -7 ± 0.100 dBVrms.

- f. For each intermodulation frequency listed in the table, perform the following steps, 1 through 3:

- (1) Press the HP35660A keys as follows:

< Average >
[AVERAGE ON/OFF]
< Freq >
[CENTER] (to intermodulation frequency in table)
< Start >
< Marker > (to intermodulation frequency in table)

- (2) Record the "A Marker Y:" reading on the test record for the channel 1 measured value.
(3) Record the "B Marker Y:" reading on the test record for the channel 2 measured value.

g. Repeats step 4a through 4f for the following frequencies:

Measurement Type	Input Signals		Intermodulation Frequency
	F1	F2	
2 CHANNEL	48 kHz	49 kHz	1 kHz 50 kHz

5. To make the 1 CHANNEL measurements, press the HP 35660A keys as follows:

< Meas Type >
[1 CHANNEL 102.4 kHz]

6. Repeat steps 4a through f for the 1 CHANNEL measurements (A display) for the following frequencies:

Measurement Type	Input Signals		Intermodulation Frequency
	F1	F2	
1 CHANNEL	89 kHz	99 kHz	10 kHz 79 kHz

If This Test Fails

If this test fails, contact your local Hewlett-Packard sales and service office or have a qualified service technician see the following sections in the HP 35660A Service Manual:

Section III – Adjustments
Second Pass Gain Adjustment
ADC Offset and Reference Adjustment

Section VII – Service: Assembly Level
One or more of the following is the most likely cause of the analyzer's failure:

A3 Input 1
A4 Input 2/ADC

13. Noise and Spurious Signals

Operation Verification – Yes

For this test, the Operation Verification Test is the same as the Performance Test.

This test measures the level of noise and spurious signals generated within the HP 35660A.

Procedure

NOTE All tests must be performed with Automatic Calibration ON. When the instrument powers up, AUTOCAL is ON, do not turn it off.

1. Connect the test equipment as shown in the following illustration. For specific information about required test equipment see Table 3-3.

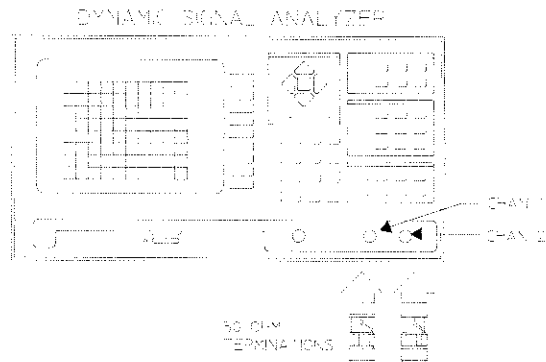

2. Press the HP 35660A keys as follows:

- < Preset >
- < Format >
[UPPER/LOWER]
- < Meas Type >
[2 CHANNEL 51.2 kHz]
- < Input >
[CHANNEL 1 RANGE] < ± > < 5 > < 1 > [dBVrms]
[CHANNEL 2 RANGE] < ± > < 5 > < 1 > [dBVrms]
[CHANNEL 1 SETUP] [AC/DC] [RETURN]
[CHANNEL 2 SETUP] [AC/DC]
- < Average >
[AVERAGE ON/OFF] [NUMBER AVERAGES] < 1 > < 6 > [ENTER]
[FAST AVG ON/OFF]
- < Active Trace > (this activates trace B)
- < Meas Data >
[SPECTRUM CHANNEL 2]
- < Active Trace > (this activates trace A)

3. For each of the start frequencies listed, perform steps a through d:

Measurement Type	Start Frequency	Frequency Span
2 CHANNEL	160 Hz	200 Hz
2 CHANNEL	360 Hz	200 Hz
2 CHANNEL	560 Hz	200 Hz
2 CHANNEL	760 Hz	200 Hz
2 CHANNEL	1.28 kHz	1.6 kHz
2 CHANNEL	24 kHz	1.6 kHz
2 CHANNEL	30 kHz	1.6 kHz
2 CHANNEL	34.2 kHz	1.6 kHz
2 CHANNEL	49 kHz	1.6 kHz
1 CHANNEL	61 kHz	1.6 kHz
1 CHANNEL	74 kHz	1.6 kHz
1 CHANNEL	74 kHz	1.6 kHz
1 CHANNEL	92 kHz	1.6 kHz
1 CHANNEL	100 kHz	1.6 kHz

- a. Press the HP 35660A keys as follows:
 - < Meas Type > (to measurement type in table)
 - < Freq >
 - [START] (to start frequency in table)
 - [SPAN] (to frequency span in table)
 - < Start >
When the average is complete, press
 - < Scale >
 - [AUTO SCALE]
 - < Marker >
 - [MARKER TO PEAK]
 - b. Record the “A Marker Y:” reading on the test record for the channel 1 measured value.
 - c. When a 2 CHANNEL measurement is done, press the HP35660A keys as follows:
 - < Active Trace >(this activates trace B)
 - < Scale >
 - [AUTO SCALE]
 - < Marker >
 - [MARKER TO PEAK]
 - < Active Trace >(this activates trace A)
 - d. When a 2 CHANNEL measurement is done, record the “B Marker Y:” reading on the test record for the channel 2 measured value.
4. Press the HP 35660A keys as follows:
- < Meas Type >
 - [2 CHANNEL 51.2 kHz]
 - < Meas Data >
 - [PSD CHANNEL 1]
 - < Active Trace >(this activates trace B)
 - [PSD CHANNEL 2]
 - < Active Trace >(this activates trace A)

5. For each of the start frequencies listed below, perform steps a through d:

Measurement Type	Start Frequency	Frequency Span
2 CHANNEL	160 Hz	12.8 kHz
2 CHANNEL	1.28 kHz	51.2kHz
1 CHANNEL	1.28 kHz	102.4 kHz

- a. Press the HP 35660A keys as follows:

< Meas Type > (to measurement type in table)

< Freq >

[START] (to start frequency in table)

[SPAN] (to frequency span in table)

< Start >

When the average is complete, press

< Scale >

[AUTO SCALE]

< Marker >

[MARKER TO PEAK]

- b. Record the “A Marker Y:” reading on the test record for the channel 1 measured value.

- c. When a 2 CHANNEL measurement is done, press the HP 35660A keys as follows:

< Active Trace >(this activates trace B)

< Scale >

[AUTO SCALE]

< Marker >

[MARKER TO PEAK]

< Active Trace >(this activates trace A)

- d. When a 2 CHANNEL measurement is done, record the “ B Marker Y:” reading on the test record for the channel 2 measured value.

If This Test Fails

If this test fails, contact your local Hewlett-Packard sales and service office or have a qualified service technician see the following sections in the *HP 35660A Service Manual*:

Section III – Adjustments

- Second Pass Gain Adjustment
- ADC Offset and Reference Adjustment
- Common Mode Adjustment

Section VII – Service: Assembly Level

One or more of the following is the most likely cause of the analyzer's failure:

- Check instrument screws are tight
- A3 Input 1
- A4 Input 2/ADC
- A1 Digital Processor

14. Cross talk

Operation Verification Test – No

Do not perform this test for Operation Verification.

This test measures the amount of energy induced by a signal on another channel. This is done by placing a high signal level on one channel and then measuring the relative signal amplitude of the other channel.

Procedure

NOTE All tests must be performed with Automatic Calibration ON. When the instrument powers up, AUTOCAL is ON, do not turn it off.

1. Connect the test equipment as shown in the following illustration. For specific information about required test equipment see Table 3-3.

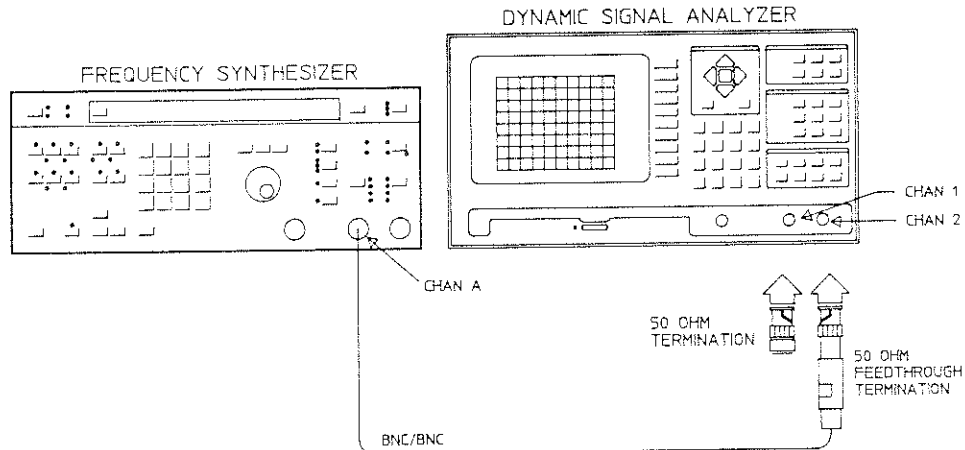

2. Configure the frequency synthesizer as follows:

Frequency Synthesizer:

Mode 2 Channel
Function SINE WAVE
Frequency 49 kHz
Amplitude 2.82 Vrms
Phase 0
dc Offset 0V
Modulation OFF
Sweep OFF

3. Press the HP 35660A keys as follows:

< Preset >
< Format >
 [UPPER/LOWER]
< Meas Type >
 [2 CHANNEL 51.2 kHz]
< Window >
 [HANNING]
< Input >
 [CHANNEL 1 RANGE] < ± > < 5 > < 1 > [dBVrms]
 [CHANNEL 2 RANGE] < 9 > [dBVrms]
 [CHANNEL 1 SETUP] [AC/DC] [RETURN]
 [CHANNEL 2 SETUP] [AC/DC]
< Freq >
 [SPAN] < 1 > < . > < 6 > [kHz]
 [CENTER] < 4 > < 9 > [kHz]
< Active Trace > (this activates trace B)
< Meas Data >
 [SPECTRUM CHANNEL2]

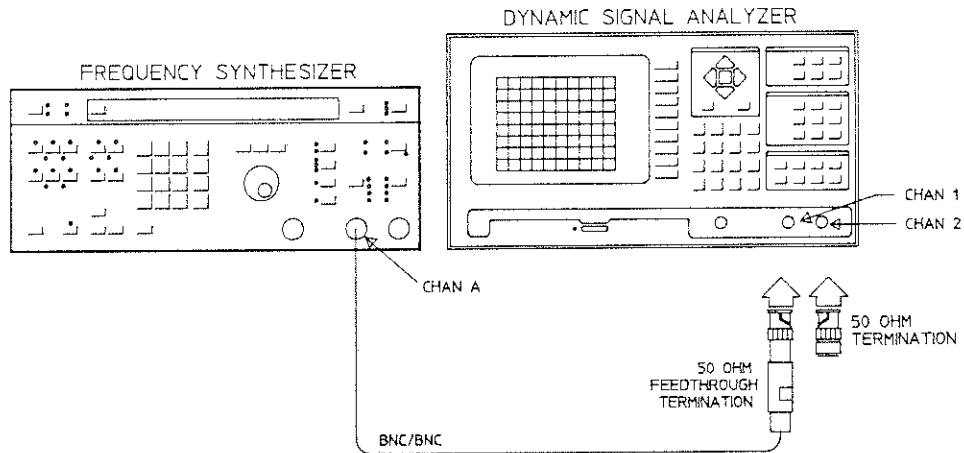

NOTE During this test the “Ovl” indicator may be on until the setups are completed. When setups are completed it should go off. This will not damage the instrument. However, measurements are not valid while the indicator is on.

4. Measure the amplitude on channel 1 relative to the signal amplitude on channel 2 by performing the following steps:
 - a. Press the HP 35660A keys as follows:
 - < Marker >
[COUPLED **ON/OFF**] < 4 > < 9 > [kHz]
 - < Scale >
[AUTO SCALE]
 - < Active Trace > (this activates trace A)
[AUTO SCALE]
 - b. Adjust the synthesizer until the "B Marker Y:" value read 9 ± 0.1 dBVrms.
 - c. Press the HP35660A keys as follows:
 - < Average >
[AVERAGE **ON/OFF**] [NUMBER AVERAGES] < 1 > < 6 > [ENTER]
[FAST AVG **ON/OFF**]
 - < Start >
 - d. Record the "A Marker Y:" reading on the test record for the channel 2 to channel 1 cross talk value.
5. Connect the test equipment as shown in the following illustration. For specific information about required test equipment see Table 3-3.

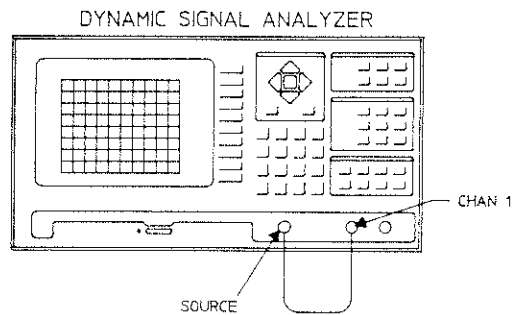

6. Measure the amplitude on channel 2 relative to the signal amplitude on channel 1 by performing the following steps:
 - a. Press the HP 35660A keys as follows:
 - < Input >
 - [CHANNEL 1 RANGE] < 9 > [dBVrms]
 - [CHANNEL 2 RANGE] < ± > < 5 > < 1 > [dBVrms]
 - < Start >
 - < Scale >
 - [AUTO SCALE]
 - < Active Trace > (this activates trace B)
 - [AUTO SCALE]
 - b. Record the “B Marker Y:” reading on the test record for the channel 1 to channel 2 crosstalk value.
7. Connect the test equipment as shown in the following illustration. For specific information about required test equipment see Table 3-3.



8. Measure the amplitude on channel 2 relative to the signal amplitude from the source by performing the following steps:
 - a. Press the HP 35660A keys as follows:
 - < Input >
 - [CHANNEL 1 RANGE] < 9 > [dBVrms]
 - [CHANNEL 2 RANGE] < ± > < 5 > < 1 > [dBVrms]
 - < Source >
 - [SOURCE **ON/OFF**] [LEVEL] < 9 > [dBVrms]
 - [SINE FREQ ENTRY] < 4 > < 9 > [kHz]
 - < Average >
 - [**ON/OFF**]
 - b. Adjust the sources level until the “ A Marker Y:” value reads 9 ± 0.1 dBVrms. By pressing the HP 35660A keys as follows:
 - < Source >
 - [LEVEL] (Use <  > <  > arrow keys to adjust source level)
 - c. Press the HP 35660 keys as follows:
 - < Average >
 - [Average **ON/OFF**]
 - < Start >
 - < Active Trace >(this activates trace A)
 - d. Record the “B Marker Y:” reading on the test record for the source-to-input crosstalk value.

If This Test Fails

If this test fails, contact your local Hewlett-Packard sales and service office or have a qualified service technician see the following sections in the *HP 35660A Service Manual*:

Section III – Adjustments

None

Service: Section VII – Assembly Level

One or more of the following is the most likely cause of the analyzer's failure:

Check that instrument screws are tight.

A3 Input 1

A4 Input 2/ADC

15. Source Residual DC Offset

Operation Verification – Yes

For this test, the Operation Verification Test is the same as the Performance Test.

This test measures the amount of residual dc offset generated by the source.

Procedure

NOTE All tests must be performed with Automatic Calibration ON. When the instrument powers up, AUTOCAL is ON, do not turn it off.

1. Connect the test equipment as shown in the following illustration. For specific information about required test equipment see Table 3-3.

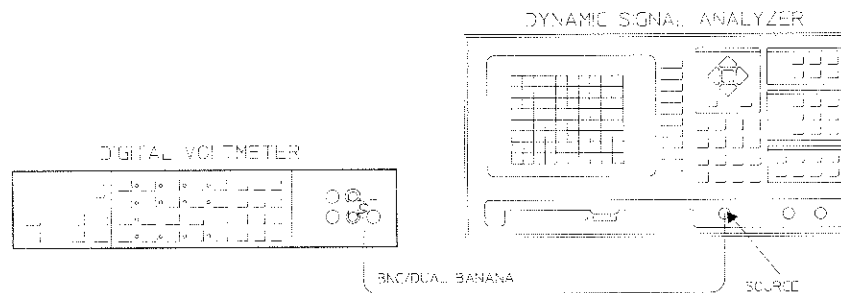

2. Configure the digital voltmeter as follows:

Digital Voltmeter:

FunctiondcV
RangeAUTO
TriggerINTERNAL
Sample RateMAXIMUM
High ResolutionON
Auto CalON

3. Press the HP 35660A keys as follows:

< Preset >
< Source >
[SOURCE ON/OFF] [SINE FREQ ENTRY] < 1 > < 0 > < 0 > [kHz]
[LEVEL] < . > < 0 > < 0 > < 1 > < 2 > < 5 > [V]

4. Record the digital voltmeter reading on the test record for the 1.25 mV setting.
5. Press the HP 35660A keys as follows:

[LEVEL] < 5 > [V]

6. Record the digital voltmeter reading on the test record for the 5V setting.

If This Test Fails

If this test fails, contact your local Hewlett-Packard sales and service office or have a qualified service technician see the following sections in the *HP 35660A Service Manual*:

Section III – Adjustments
None

Section VII – Service: Assembly Level
One or more of the following is the most likely cause of the analyzer's failure:

A1 Digital Processor

16. Source Amplitude Accuracy and Flatness

Operation Verification – Yes

For this test, the Operation Verification Test is the same as the Performance Test.

This test measures the amplitude accuracy and flatness of the source.

Procedure

NOTE All tests must be performed with Automatic Calibration ON. When the instrument powers up, AUTOCAL is ON, do not turn it off.

1. Connect the test equipment as shown in the following illustration. For specific information about required test equipment see Table 3-3.

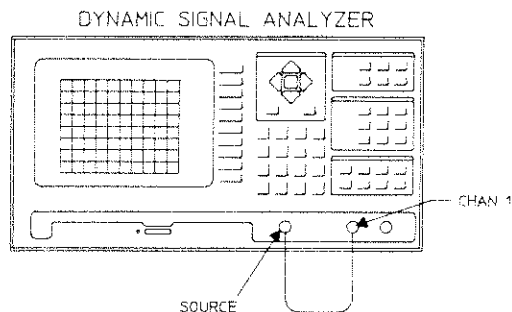

2. Press the HP 35660A keys as follows:

```

< Preset >
< Input >
  [ CHANNEL 1 SETUP ] [ AC/DC ] [ RETURN ]
  [ CHANNEL 2 SETUP ] [ AC/DC ]
< Freq >
  [ SPAN ] < 1 > < . > < 6 > [ kHz ]
  [ CENTER ] < 1 > [ kHz ]
< Average >
  [ AVERAGE ON/OFF ]
  [ FAST AVG ON/OFF ]
< Source >
  [ SOURCE ON/OFF ]
  [ SINE FREQ ENTRY ] < 1 > [ kHz ]
< Trace Type >
  [ LINEAR MAGNITUDE ]
< Scale >
  [ VERTICAL/DIV ] < 1 > < V >
  
```

3. For each of the source levels shown, perform steps a and b:

Source Level	Range Setting
0.1 V	0.1 V
3 V	3 V
5 V	5 V

a. Press the HP 35660A keys as follows:

```

< Input >
  [ CHANNEL 1 RANGE ] (to range setting in table)
< Source >
  [ LEVEL ] (to source level in table)
< Start >
< Marker >
  < 1 > [ kHz ]
  
```

b. Record the “A Marker Y:” reading on the test record under the source amplitude measured value.

4. Press the HP 35660A keys as follows:

< Input >
[CHANNEL 1 RANGE] < 1 > < 1 > [dBVrms]
< Trace Type >
[LOG MAGNITUDE]
< Source >
[LEVEL] < 5 > [V]
< Start >

5. After the measurement is complete, press the following keys on the HP 35660A:

< Marker >
[OFFSET]
[OFFSET ON] [OFFSET ZERO]

6. Amplitude flatness is measured relative to 1 kHz. Follow the steps first to measure the amplitude at 1 kHz, then to measure the amplitude at the test frequency. Perform steps a through c:

Source Frequency
10 kHz
50 kHz
99 kHz

- a. Press the HP 35660A keys as follows:

< Source >
[SINE FREQ ENTRY] (to frequency in table)
< Freq >
[CENTER] (to frequency in table)
< Start >
< Marker >
[MARKER TO PEAK]

- b. Record the "A Marker Y:" reading on the test record under relative flatness measured value .

If This Test Fails

If this test fails, contact your local Hewlett-Packard sales and service office or have a qualified service technician see the following sections in the *HP 35660A Service Manual*:

Section III – Adjustments

None

Section VII – Service: Assembly Level

One or more of the following is the most likely cause of the analyzer's failure:

A1 Digital Processor

17. Source Output Distortion

Operation Verification – Yes

For this test, the Operation Verification Test is the same as the Performance Test.

This test measures the amount of distortion generated by the source.

Procedure

NOTE All tests must be performed with Automatic Calibration ON. When the instrument powers up, AUTOCAL is ON, do not turn it off.

1. Connect the test equipment as shown in the following illustration. For specific information about required test equipment see Table 3-3.

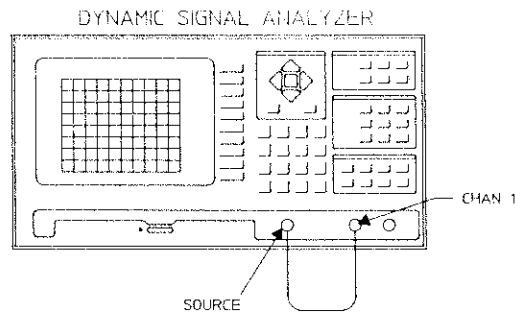

2. Press the HP 35660A keys as follows:

< Preset >
< Scale >
 [VERTICAL/DIV] < 1 > < 5 > [dB]
< Freq >
 [START] < 1 > [kHz]
< Input >
 [CHANNEL 1 SETUP] [AC/DC] [RETURN]
 [CHANNEL 2 SETUP] [AC/DC]
< Average >
 [AVERAGE **ON**/OFF]
 [NUMBER AVERAGES] < 4 > [ENTER]
 [FAST AVG **ON**/OFF]
< Source >
 [SOURCE **ON**/OFF]
 [SINE FREQ ENTRY] < 1 > < 0 > [kHz]
 [LEVEL] < 5 > [V]
< Start >
< Input >
< Scale >
 [AUTO SCALE]
< Marker >
 < 1 > < 0 > [kHz]
 [OFFSET]
 [OFFSET **ON**/OFF]
 [OFFSET ZERO]
 [RETURN]

Use [NXT RIGHT PEAK] and [NXT LEFT PEAK] or marker arrow keys to determine the peak distortion value.

3. Record the peak distortion value (A offset Y:) on the test record.

4. Press the HP 35660A keys as follows:

```
< Source >  
  [ SINE FREQ ENTRY ] < 1 > < 0 > < 0 > [ kHz ]  
  
< Start >  
  
< Marker >  
  < 1 > < 0 > < 0 > [ kHz ]  
  [ OFFSET ]  
  [ OFFSET ZERO ]  
  [ RETURN ]
```

Use [NXT RIGHT PEAK] and [NXT LEFT PEAK] or marker arrow keys to determine the peak distortion value.

5. Record the peak distortion value (A offset Y:) on the test record.

If This Test Fails

If this test fails, contact your local Hewlett-Packard sales and service office or have a qualified service technician see the following sections in the *HP 35660A Service Manual*:

Adjustments

None

Section VII – Service: Assembly Level

One or more of the following is the most likely cause of the analyzer's failure:

A1 Digital Processor

18. Source Output Resistance

Operation Verification Test – No

Do not perform this test for Operation Verification.

This test measures the source output resistance.

Procedure

NOTE All tests must be performed with Automatic Calibration ON. When the instrument powers up, AUTOCAL is ON, do not turn it off.

Preset the digital voltmeter as follows:

Digital Voltmeter

Function 2 wire k Ω
Range AUTO
Trigger INTERNAL
Sample Rate MAXIMUM
High Resolution ON
Auto Cal ON

1. Measure the resistance of the 50 Ω termination that is to be used in this test.
2. Record the resistance of the termination on the test record as R1.

3. Connect the test equipment as shown in the following illustration. For specific information about required test equipment see Table 3-3.

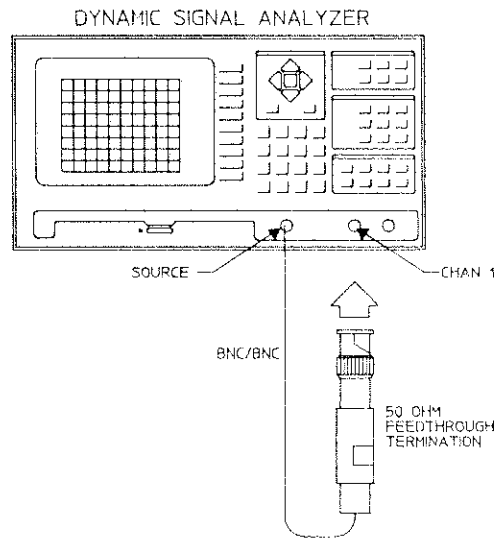

4. Press the HP35660A keys as follows:

```
< Preset >
< Input >
  [ CHANNEL 1 RANGE ] < + > < 1 > [ dBVrms ]
  [ CHANNEL 1 SETUP ]
  [ AC/DC ]
< Window >
  [ UNIFORM ]
< Freq >
  [ SPAN ] < 1 > < . > < 6 > [ kHz ]
  [ CENTER ] < 1 > < 0 > [ kHz ]
< Average >
  [ AVERAGE ON/OFF ]
< Source >
  [ SOURCE ON/OFF ]
  [ LEVEL ] < 1 > [ dBVrms ]
  [ SINE FREQ ENTRY ] < 1 > < 0 > [ kHz ]
< Start >
< Trace Type >
  [ LINEAR MAGNITUDE ]
< Marker >
  [ MARKER TO PEAK ]
```

5. Record the "A Marker Y:" measurement as V1 on the test record.
6. Remove the 50Ω termination from the signal path and connect the output directly to channel 1.
7. Press

< Start >

8. Record the "A Marker Y:" measurement as V2 on the test record.

$$R_s = R_1 \left(\frac{V_2 - V_1}{V_1} \right)$$

9. Use the following formula to calculate the source output resistance:

If This Test Fails

If this test fails, contact your local Hewlett-Packard sales and service office or have a qualified service technician see the following sections in the *HP 35660A Service Manual*:

Section III – Adjustments
None

Section VII – Service: Assembly Level
One or more of the following is the most likely cause of the analyzer's failure:

A1 Digital Processor

Chapter 4

HP 35660A Installation

Getting Ready

Incoming Inspection

The HP 35660A Dynamic Signal Analyzer was carefully inspected both mechanically and electrically before shipment. It should be free of marks or scratches and in perfect electrical order upon receipt. Shipped with the analyzer is the power cord and the plastic transportation disc, part number HP 1150-1787 (unless disc drive is deleted, see options).

Inspect the analyzer for physical damage incurred in transit. If the analyzer was damaged in transit, save all packing materials, file a claim with the carrier, and call your Hewlett-Packard sales and service office.

CAUTION *If the analyzer is mechanically damaged, the integrity of the protective earth ground may be interrupted. Do not connect the analyzer to power if it is damaged.*

Incoming Tests

WARNING **Before applying line power to the analyzer or testing its electrical performance, see Chapter 4, "Installation."**

Finish incoming inspection by testing the electrical performance of the analyzer using the operational verification or the performance tests in chapter 3 of this installation guide – "Operation Verification Tests and Performance Tests." The operation verification tests verify the basic operating integrity of the analyzer; these tests take about two hours to complete. The performance tests verify that the analyzer meets all the performance specifications; these tests take about four hours to complete.

Dimensions and Weight

Weight and dimension specifications are listed in Chapter 2, "Specifications."

Power Requirements

The analyzer can operate from a single-phase ac power source supplying voltages as shown in Table 4-1. With all options installed, power consumption is less than 280VA.

The line-voltage selector switch is set at the factory to match the most commonly used line voltage of the country of destination; the appropriate fuse is also installed. To check or change either the line-voltage selector switch or the fuse see Figure 4-1, Table 4-1, and the following procedures.

WARNING Only a qualified service person, aware of the hazards involved, should measure the line voltage.

CAUTION Before applying ac line power to the analyzer, ensure the line-voltage selector switch (on the rear panel) is set for the proper line voltage and the correct line fuse is installed in the fuse holder.

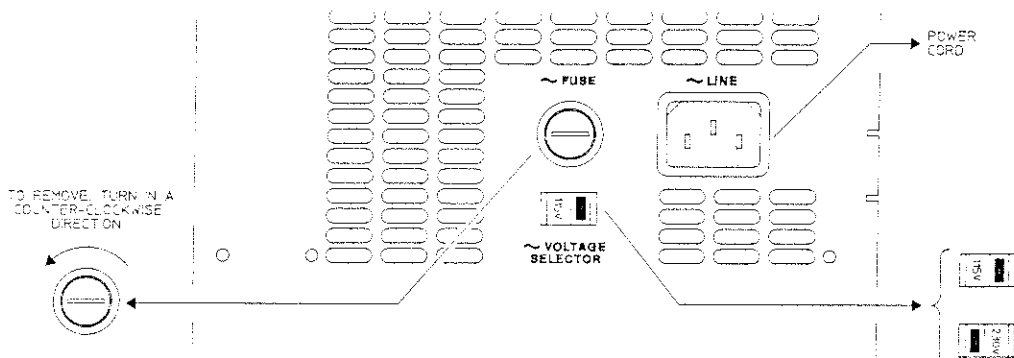

Figure 4-1 Voltage Selection and Fuse Replacement

Table 4-1 Line Voltage Ranges and Fuse Selection

AC Line Voltage		Selector Switch	Fuse	
Range	Frequency		HP Part Number	Type
90-132Vac	48-440	115	2110-0056	6A 250V Fast Acting
180-264Vac	48-66	230	2110-0003	3A 250V Fast Acting

To change the line voltage selector switch:

See Figure 4-1 and Table 4-1

1. Unplug the power cord from the analyzer.
2. Slide the Line Voltage Selector switch to the proper voltage.

To change the fuse

See Figure 4-1 and Table 4-1

1. Unplug the power cord from the analyzer.
2. Using a small screw driver, turn the fuse holder cap to the left and remove, (counter-clockwise). When the fuse cap is free from the housing.
3. Pull the fuse from the fuse holder cap.
4. To reinstall, select the proper fuse and reverse the removal procedure.

Power Cable and Grounding Requirements

The analyzer is equipped with a three-conductor power cord which grounds the analyzer when plugged into an appropriate receptacle. The type of power cable plug shipped with each analyzer depends on the country of destination. See Figure 4-2 for the available power cables and plug configurations.

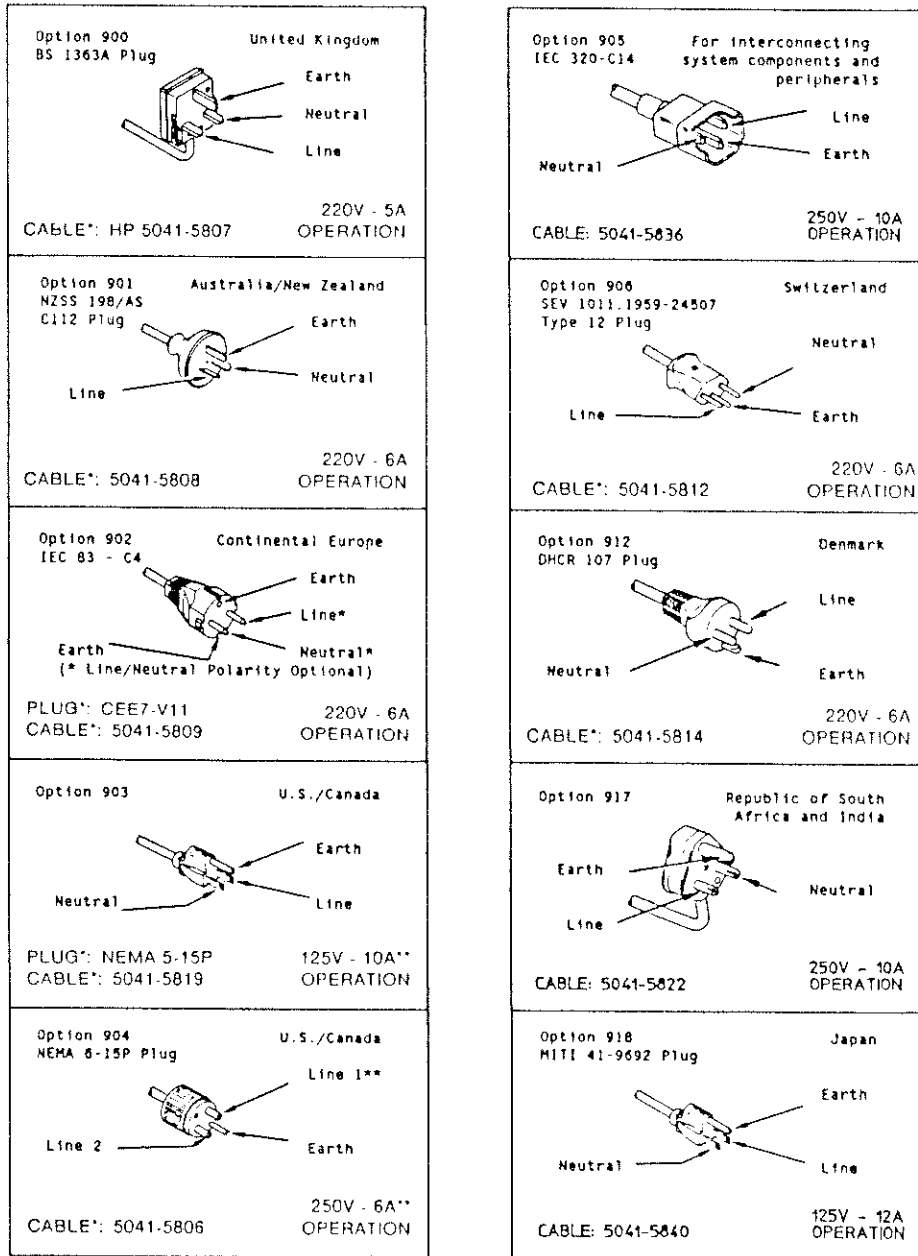

- *The number shown for the plug is the industry identifier for the plug only
The number shown for the cable is an HP part number for a complete cable including the plug
- **UL listed for use in the United States of America

WARNING The power cable plug must be inserted into an outlet provided with a protective earth terminal. Defeating the protection of the grounded analyzer cabinet can subject the operator to lethal voltages.

Screen (CRT) Cleaning

The analyzer screen is covered with a mesh (this is not removable by the operator). Under normal operating conditions the only cleaning required will be an occasional dusting with a soft brush. A household-type tack cloth, or other type of lint remover, may also be used.

However, if a foreign material adheres itself to the screen, dampen a soft, lint-free cloth, with a mild detergent mixed in water, and carefully wipe the screen.

WARNING Do not apply any water mixture directly to the screen or allow moisture to go behind the front panel. Moisture behind the front panel will severely damage the instrument.

To prevent damage to the screen, do not use cleaning solutions other than the above.

Analyzer Cooling

Cooling air enters the analyzer through the left side and exhausts through the rear panel. Install the analyzer to allow free circulation of cooling air.

Installation

The analyzer is shipped with plastic feet in place, ready for use as a portable bench analyzer. The plastic feet are shaped to make full-width modular instruments self-align when they are stacked.

To install the analyzer in an equipment cabinet, follow the instructions shipped with the rack mount kit, option 908.

Turning on the HP 35660A

First, apply proper line power to the analyzer, then press the rocker-switch in the lower left-hand corner of the analyzer to ON (I). The analyzer requires a few minutes to warm up and self-calibrate before any message appears on the display.

When turning on the analyzer for the first time, run the analyzer self test to ensure proper operation, see Chapter 3, "Operation Verification Tests and Performance Tests."

For measurement specific information, or other operating information, see the *HP 35660A Getting Started Guide*, or other appropriate manual, see the documentation map included with the analyzer.

HP-IB System Interface Connections

The analyzer is compatible with the Hewlett-Packard Interface Bus (HP-IB). The HP-IB is Hewlett-Packard's implementation of IEEE Standard 488.2. The analyzer is connected to the HP-IB by connecting an HP-IB interface cable to the connector located on the rear panel. Total allowable transmission path length is 2 meters times the number of devices or 20 meters, whichever is less. Operating distances can be extended using an HP-IB Extender.

For additional HP-IB programming information, see the *HP 35660A HP-IB Programming Reference*.

CAUTION *The analyzer contains metric threaded HP-IB cable mounting studs as opposed to English threads. Use only metric threaded HP-IB cable lockscrews to secure the cable to the analyzer. Metric threaded fasteners are black, while English threaded fasteners are silver.*

Operating Environment

The operating and storage environment specifications for the analyzer, with and without the disc drive, are listed in this guide in Chapter 2, "Specifications."

WARNING **To prevent potential fire or shock hazard, do not expose the analyzer to rain or other excessive moisture.**

Protect the analyzer from moisture and temperatures or temperature changes which cause condensation within the analyzer.

NOTE The disc drive is designed for operation in a typical office environment. Use of the equipment in an environment containing dirt, dust, or corrosive substances will drastically reduce the life of the disc drive and the flexible discs. The discs should be stored in a dry, static-free environment.

Storage and Shipment

Storage

Store the analyzer in a clean, dry, and static free environment. For other requirements, see environmental specifications in Chapter 2, "Specifications."

Shipment

CAUTION When transporting the analyzer (with disc drive), insert the plastic disc protector, part number HP1150-1787, into the disc drive to prevent damage.

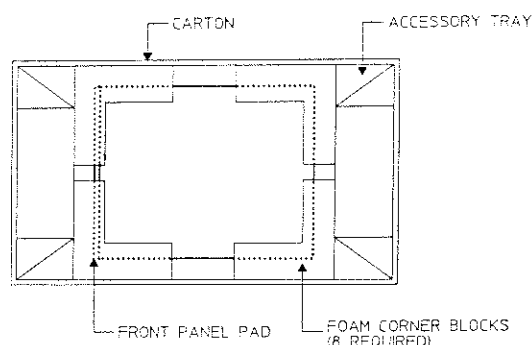

Figure 4-3 Repackaging for Shipment

Containers and materials identical to those used in factory packaging are available through Hewlett-Packard offices, see Figure 4-3. If the analyzer is being returned to Hewlett-Packard for service, attach a tag describing the type of service required, the return address, model number, and full serial number. Also, mark the container **FRAGILE** to ensure careful handling. In any correspondence, refer to the analyzer by model number and full serial number.

If it is necessary to package the analyzer in a container other than original packaging observe the following (use of other packaging is not recommended):

- Protect the front panel with cardboard and wrap the analyzer in heavy paper or anti-static plastic.
- Use a double-wall carton made of at least 350-pound test material and cushion the analyzer to prevent damage.
- Identify the shipment as above and mark **FRAGILE**.

CAUTION Do not use styrene pellets in any shape as packing material for the analyzer. The pellets do not adequately cushion the analyzer and do not prevent the analyzer from shifting in the carton. In addition, the pellets create static electricity which can damage electronic components.

Index

- Cooling **4-5**
- CRT Cleaning **4-5**
- Dimensions **2-4**
- Environmental Specifications **2-4**

- Frequency Range **1-1, 2-2**
- Front Panel Connectors **1-1**
- Fuse **4-2**

- Grounding Requirements **4-4**

- HP-IB **4-6**
 - IEEE Standard 488.2 **4-6**
 - System Interface Connections **4-6**
 - Transmission Path Length **4-6**

- Incoming Inspection **4-1**
- Initial Turn-On **4-7**
- Installation
 - Bench **4-5**
 - Rack Mount **4-5**

- Line-Voltage Selector Switch **4-2**

- Operating Environment **4-6**
- Operation Verification Tests
 - Test Record
 - Test Confidence Level **3-1**
 - Test Duration **3-1**
 1. Self Test **3-7**
 2. DC Response **3-8**
 3. Amplitude Accuracy and Flatness **3-11**
 5. Amplitude and Phase Match **3-19**
 7. Frequency Accuracy **3-27**
 9. Single Channel Phase Accuracy **3-33**
 13. Noise and Spurious Signals **3-50**
 15. Source Residual DC Offset **3-60**
 16. Source Amplitude Accuracy and Flatness **3-62**
 17. Source Output Distortion **3-66**
- Options **1-2**

- Performance Tests
 - Test Record
 - Test Confidence Level **3-1**
 - Test Duration **3-1**
 1. Self Test **3-7**
 2. DC Response **3-8**
 3. Amplitude Accuracy and Flatness **3-11**
 4. Amplitude Linearity **3-16**
 5. Amplitude and Phase Match **3-19**
 6. Anti-Alias Filter Response **3-23**
 7. Frequency Accuracy **3-27**
 8. Input Coupling Insertion Loss **3-30**
 9. Single Channel Phase Accuracy **3-33**
 10. Input Impedance **3-36**
 11. Harmonic Distortion **3-42**
 12. Intermodulation Distortion **3-46**
 13. Noise and Spurious Signals **3-50**
 14. Cross talk **3-55**
 15. Source Residual DC Offset **3-60**
 16. Source Amplitude Accuracy and Flatness **3-62**
 17. Source Output Distortion **3-66**
 18. Source Output Resistance **3-69**
- Peripherals **2-4**
- Power Cables **4-4**
- Power Consumption **2-4, 4-2**
- Power Requirements **2-4, 4-2**

- Rear Panel Connectors **1-1**

- Screen (CRT) Cleaning **4-5**
- Serial Numbers **1-3**
- Shipment **4-8**
- Software Revision Code **1-4**
- Storage **4-8**

- Test Duration **4-1**
- Transportation Disc **4-1**
- Weight **2-4**

P/O A4 CH 2 INPUT & ADC BOARD
35660-66504 REV B

Input Relays Pin Locations

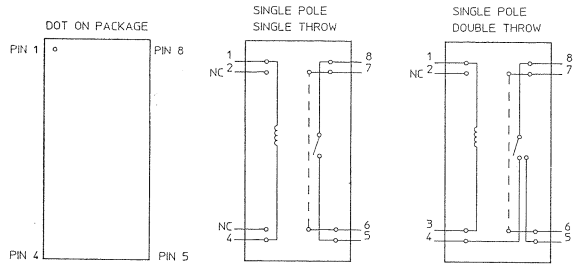

NOTE See back of this foldout for the component locator

INPUT RELAYS

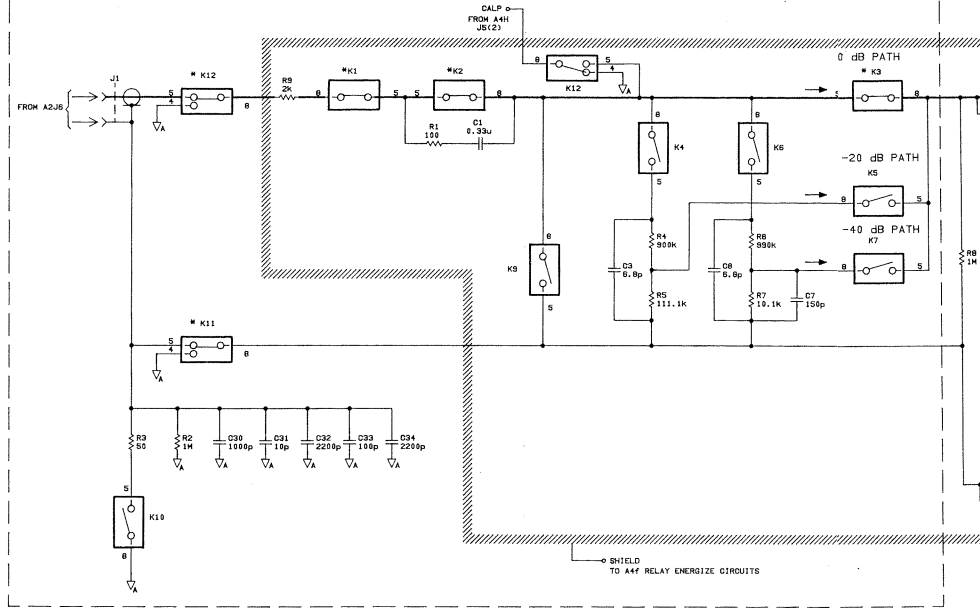

* ALL RELAYS ARE NORMALLY OPEN (WHEN DE-ENERGIZED).
RELAYS K1, K2, K3, K11, & K12 ARE SHOWN WITH THE
0 dB PATH & FLOAT MODE SELECTED.

HI INPUT PROTECTION

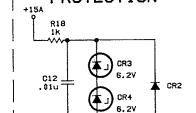

HI BUFFER

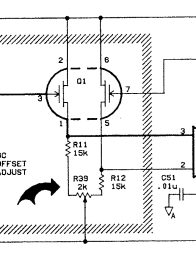

HI BOOTSTRAP

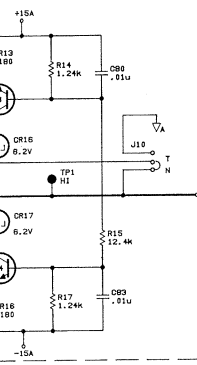

LOW INPUT PROTECTION

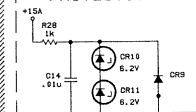

LOW BUFFER

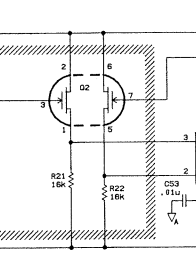

LOW BOOTSTRAP

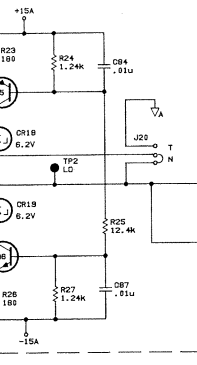

A4a Component Locator

A4a Component Locations

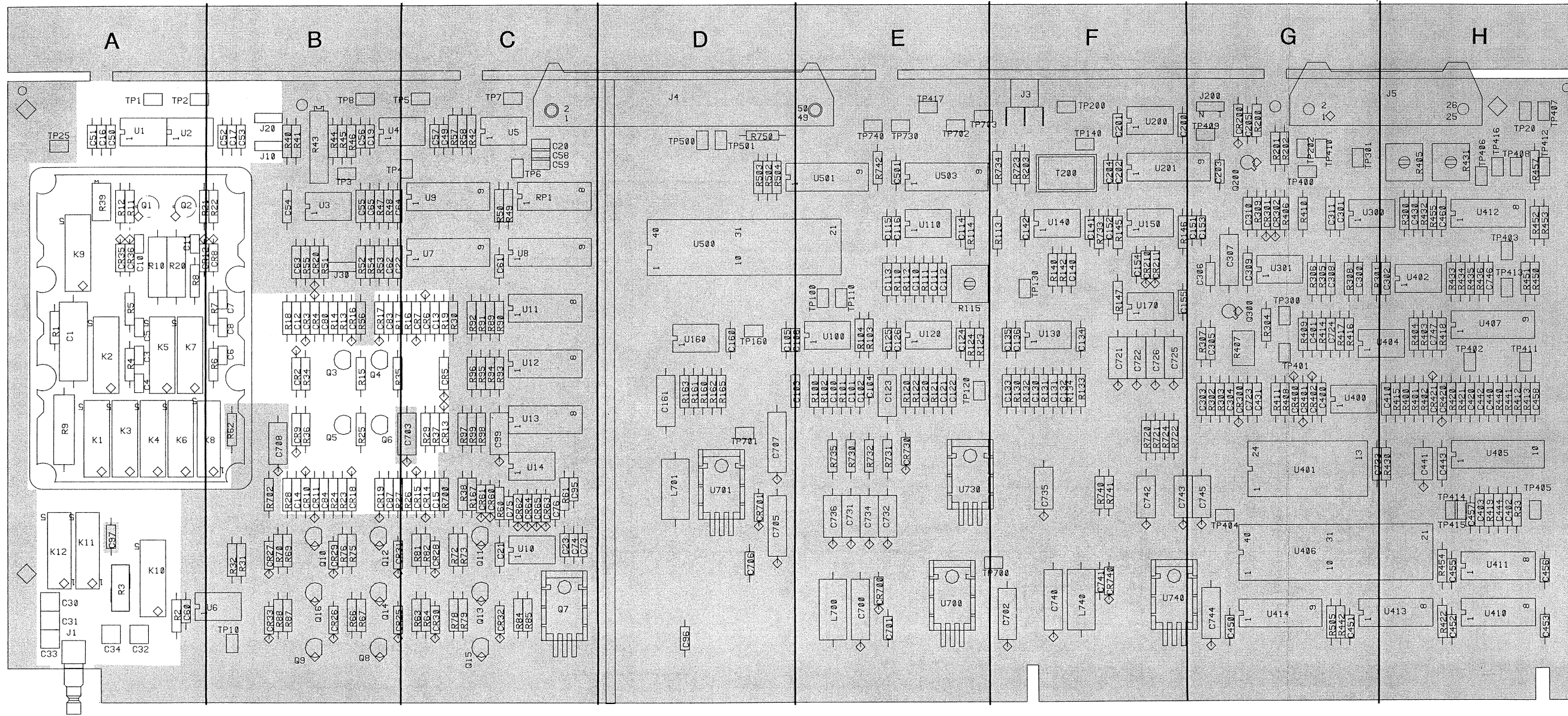

Comp.	Area	Comp.	Area
C001	A	K005	A
C003	A	K006	A
C007	B	K007	A
C008	B	K008	B
C010	A	K009	A
C011	A	K010	A
C012	B	K011	A
C013	C	K012	A
C014	B	Q001	A
C015	C	Q002	A
C016	A	Q003	B
C017	B	Q004	B
C030	A	Q005	B
C031	A	Q006	B
C032	A	R001	A
C033	A	R002	A
C034	A	R003	A
C050	A	R004	A
C051	A	R005	A
C052	B	R006	B
C053	B	R007	B
C080	B	R008	A
C083	B	R009	A
C084	B	R010	A
C087	B	R011	A
CR002	B	R012	A
CR003	B	R013	B
CR004	B	R014	B
CR005	C	R015	B
CR006	C	R016	C
CR007	C	R017	B
CR008	B	R018	B
CR009	B	R019	C
CR010	B	R020	A
CR011	B	R021	A
CR012	A	R022	B
CR013	C	R023	B
CR014	C	R024	B
CR015	C	R025	B
CR016	B	R026	C
CR017	B	R027	B
CR018	B	R028	B
CR019	B	R029	C
CR035	A	R034	B
CR036	A	R035	B
J001	A	R036	B
J010	B	R037	C
J020	B	R039	A
K001	A	TP001	A
K002	A	TP002	A
K003	A	U001	A
K004	A	U002	A

F/0 A4 CH 2 INPUT & ADC BOARD
35660-66504 REV B

GAIN & ATTENUATION STAGES

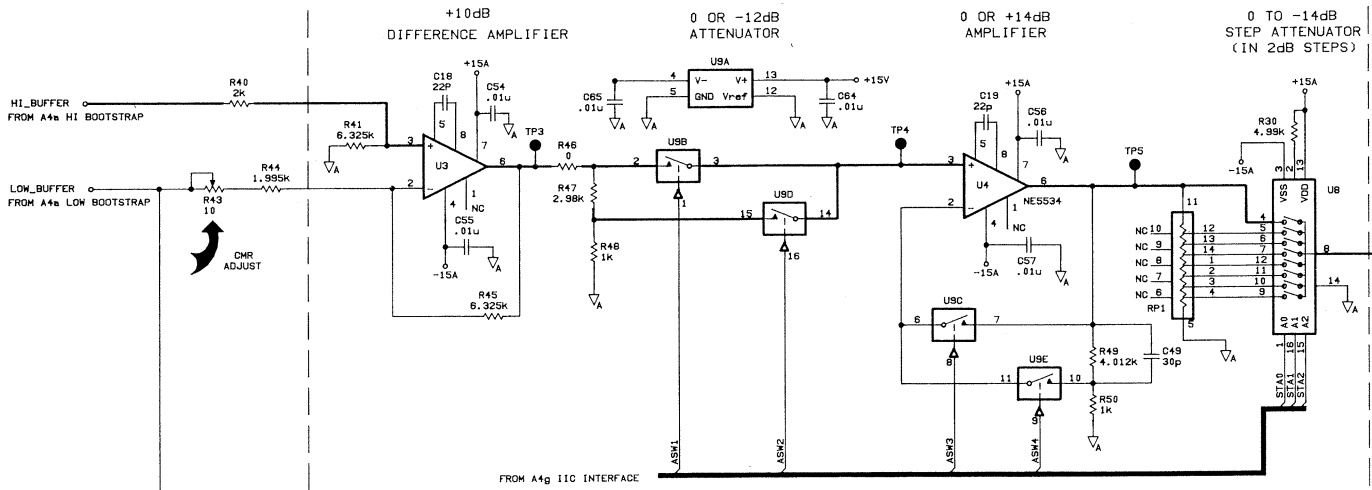

+2dB AMPLIFIER (WITH VARIABLE DC OFFSET)

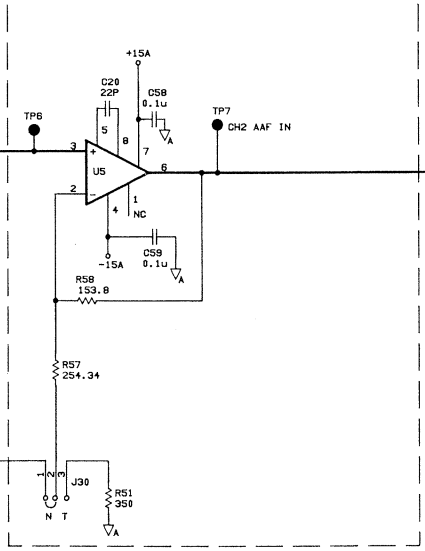

A4b Component Locator

A4b Component Locations

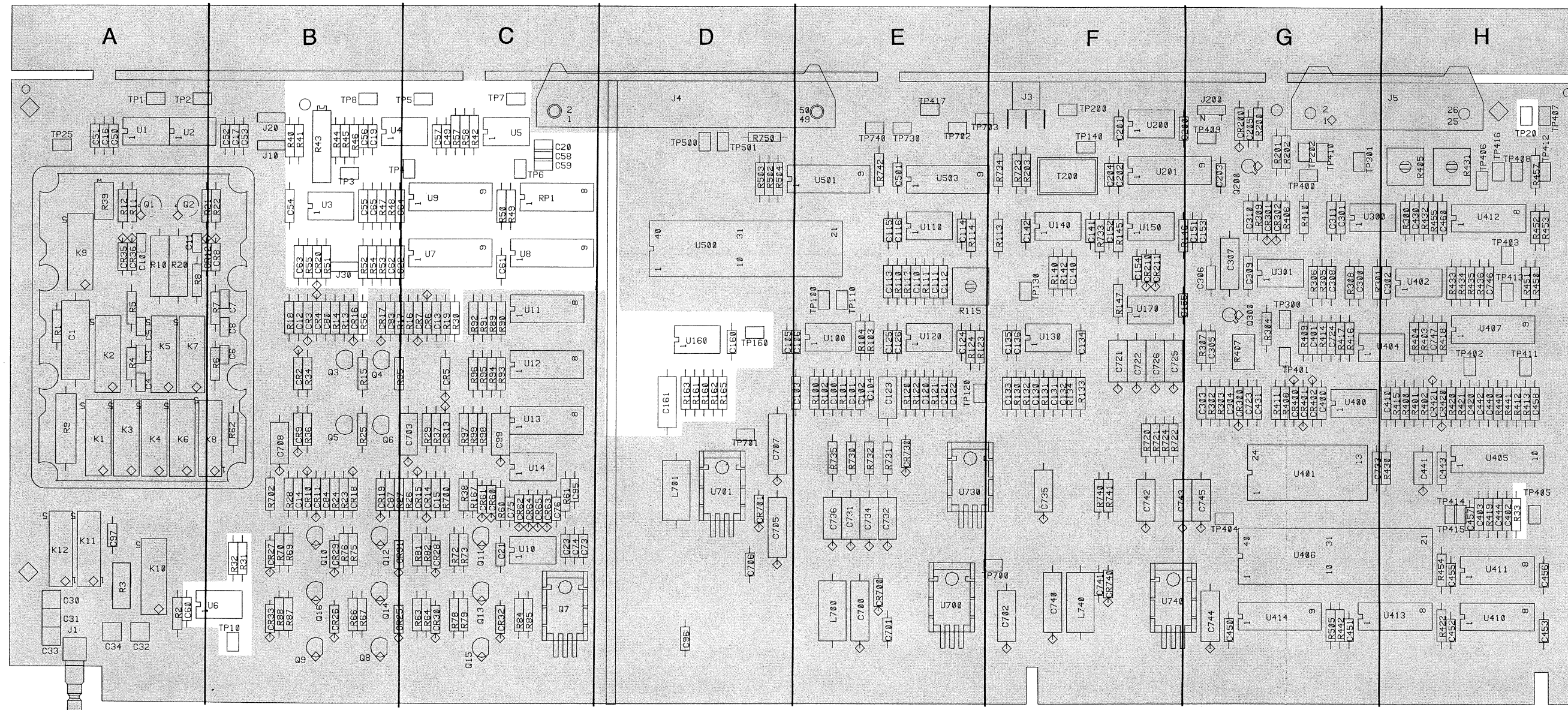

Comp.	Area	Comp.	Area
C019	B	R049	C
C020	C	R050	C
C022	B	R051	B
C049	C	R052	B
C054	B	R053	B
C055	B	R054	B
C056	B	R055	B
C057	C	R056	B
C058	C	R057	C
C059	C	R058	C
C060	A	R160	D
C061	C	R161	D
C062	B	R162	D
C063	B	R163	D
C064	B	R165	D
C065	B	RP1	C
C160	D	TP003	B
C161	D	TP004	C
CR020	B	TP005	C
J030	B	TP006	C
R030	C	TP007	C
R031	B	TP008	B
R032	B	TP010	B
R033	H	TP020	H
R040	B	TP160	D
R041	B	U003	B
R042	C	U004	B
R043	B	U005	C
R044	B	U006	B
R045	B	U007	C
R046	B	U008	C
R047	B	U009	C
R048	B	U160	D

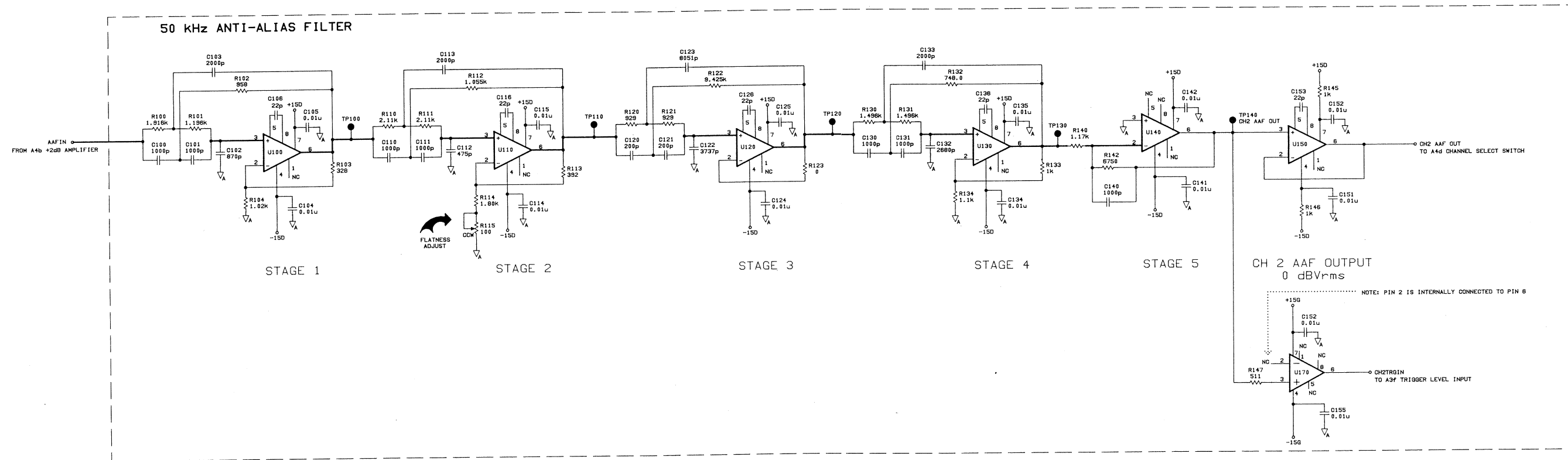
P/O
A4CHANNEL 2 INPUT & ADC BOARD
35660-66504 REV B

A4c Component Locator

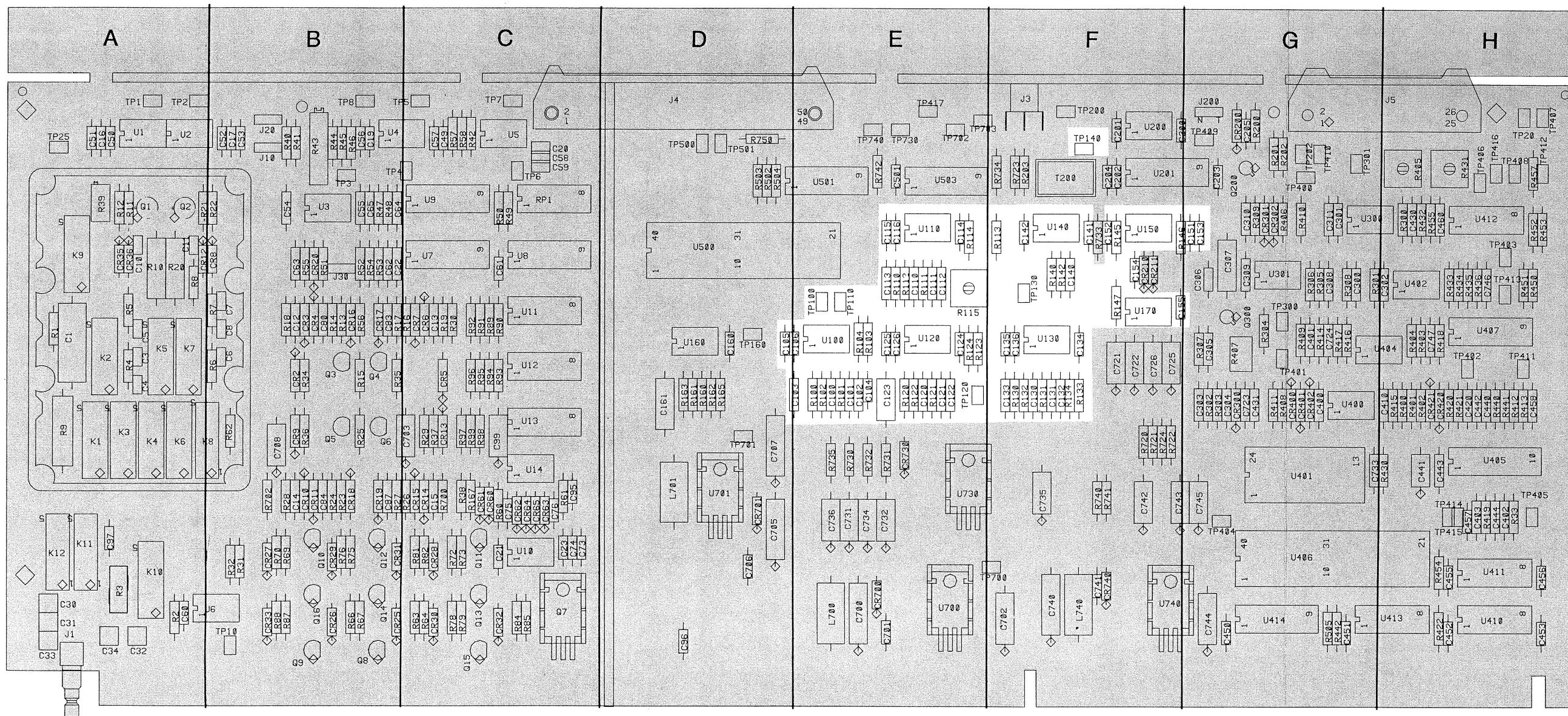

A4c Component Locations

Comp.	Area	Comp.	Area
C100	E	R101	E
C101	E	R102	E
C102	E	R103	E
C103	E	R104	E
C104	E	R110	E
C105	D	R111	E
C106	E	R112	E
C110	E	R113	F
C111	E	R114	E
C112	E	R115	E
C113	E	R120	E
C114	E	R121	E
C115	E	R122	E
C116	E	R123	E
C120	E	R130	F
C121	E	R131	F
C122	E	R132	F
C123	E	R133	F
C124	E	R134	F
C125	E	R140	F
C126	E	R142	F
C130	F	R145	F
C131	F	R146	F
C132	F	R147	F
C133	F	TP100	E
C134	F	TP110	E
C135	F	TP120	E
C136	F	TP130	F
C140	F	TP140	F
C141	F	U100	E
C142	F	U110	E
C151	G	U120	E
C152	F	U130	F
C153	G	U140	F
C154	F	U150	F
C155	F	U170	F
R100	E		

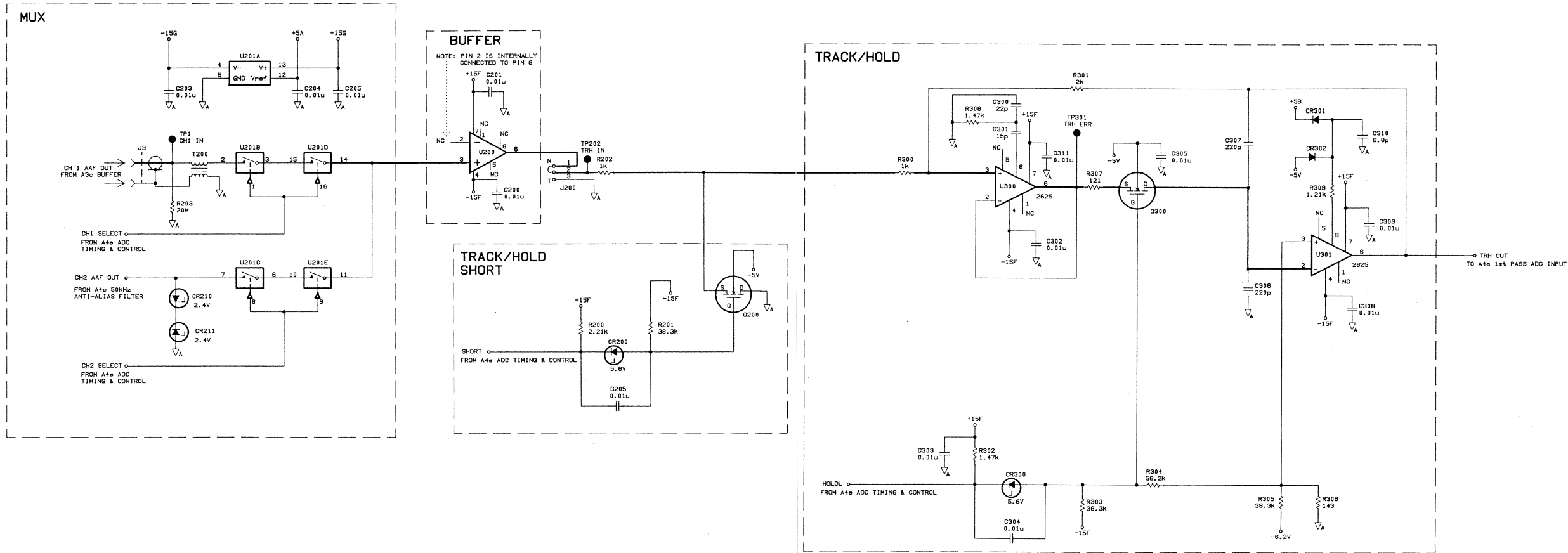

A4d Component Locator

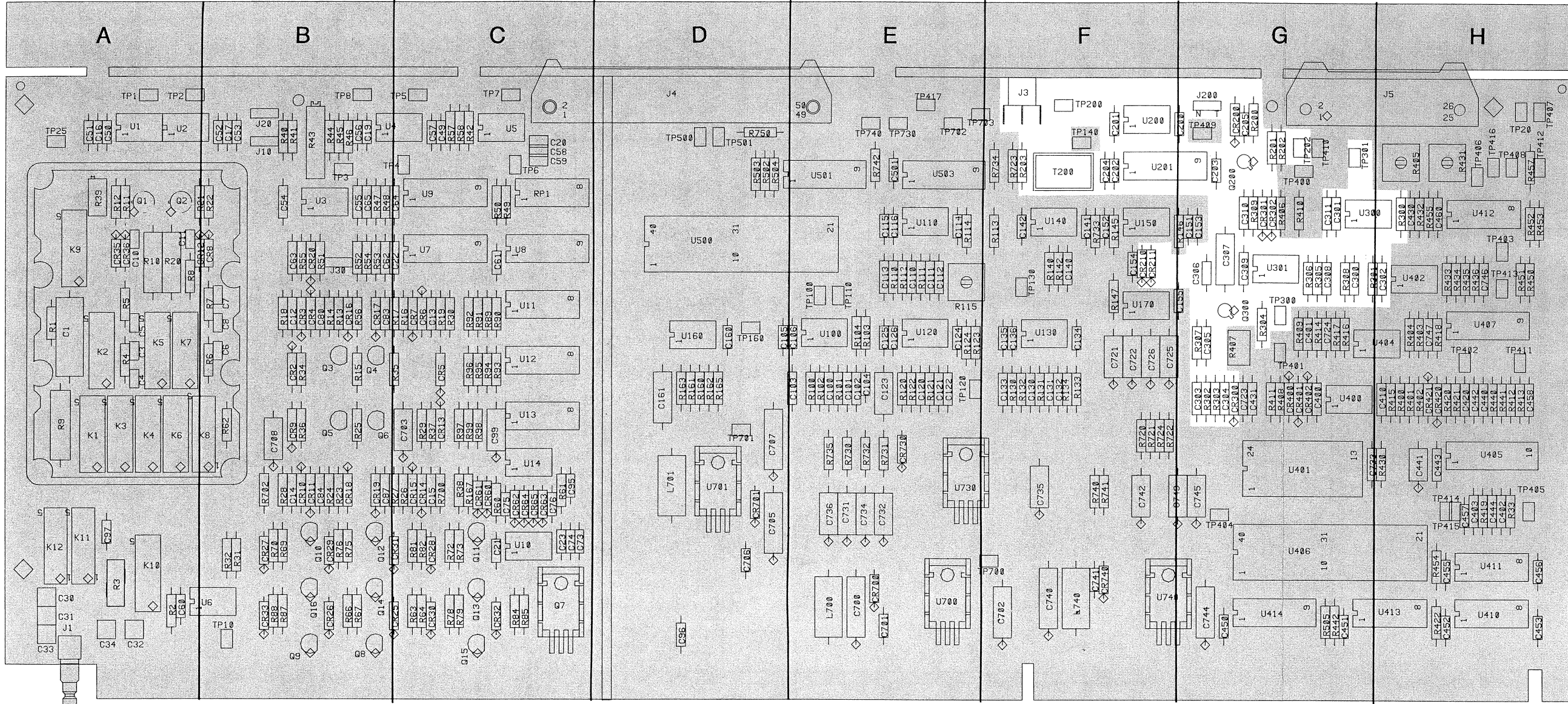

A4d Component Locations

Comp.	Area	Comp.	Area
C200	G	Q200	G
C201	F	Q300	G
C202	F	R200	G
C203	G	R201	G
C204	F	R202	G
C205	G	R203	F
C300	G	R300	H
C301	G	R301	G
C302	H	R302	G
C303	G	R303	G
C304	G	R304	G
C305	G	R305	G
C306	G	R306	G
C307	G	R307	G
C308	G	R308	G
C309	G	R309	G
C310	G	T200	F
C311	G	TP200	F
CR200	G	TP202	G
CR210	F	TP300	G
CR211	F	TP301	G
CR300	G	U200	F
CR301	G	U201	F
CR302	G	U300	G
J003	F	U301	G
J200	G		

P/0 A4 CHANNEL 2 INPUT & ADC BOARD 35660-66504 REV B

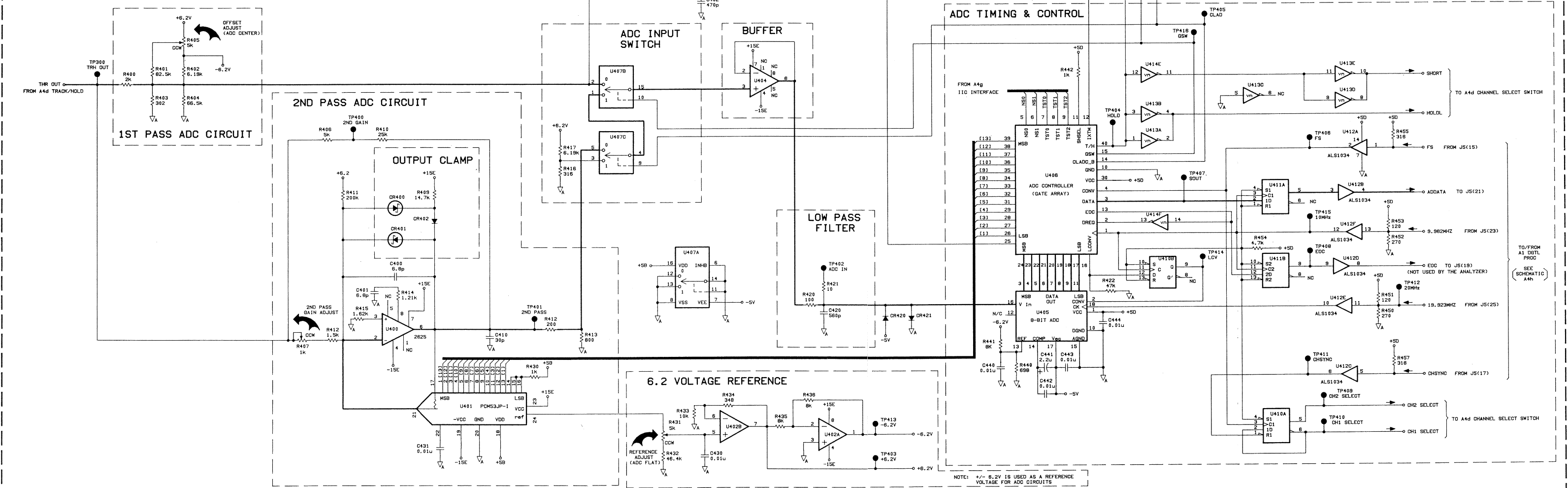

NOTE: +/- 6.2V IS USED AS A REFERENCE VOLTAGE FOR ADC CIRCUITS

A4e Component Locator

A4e Component Locations

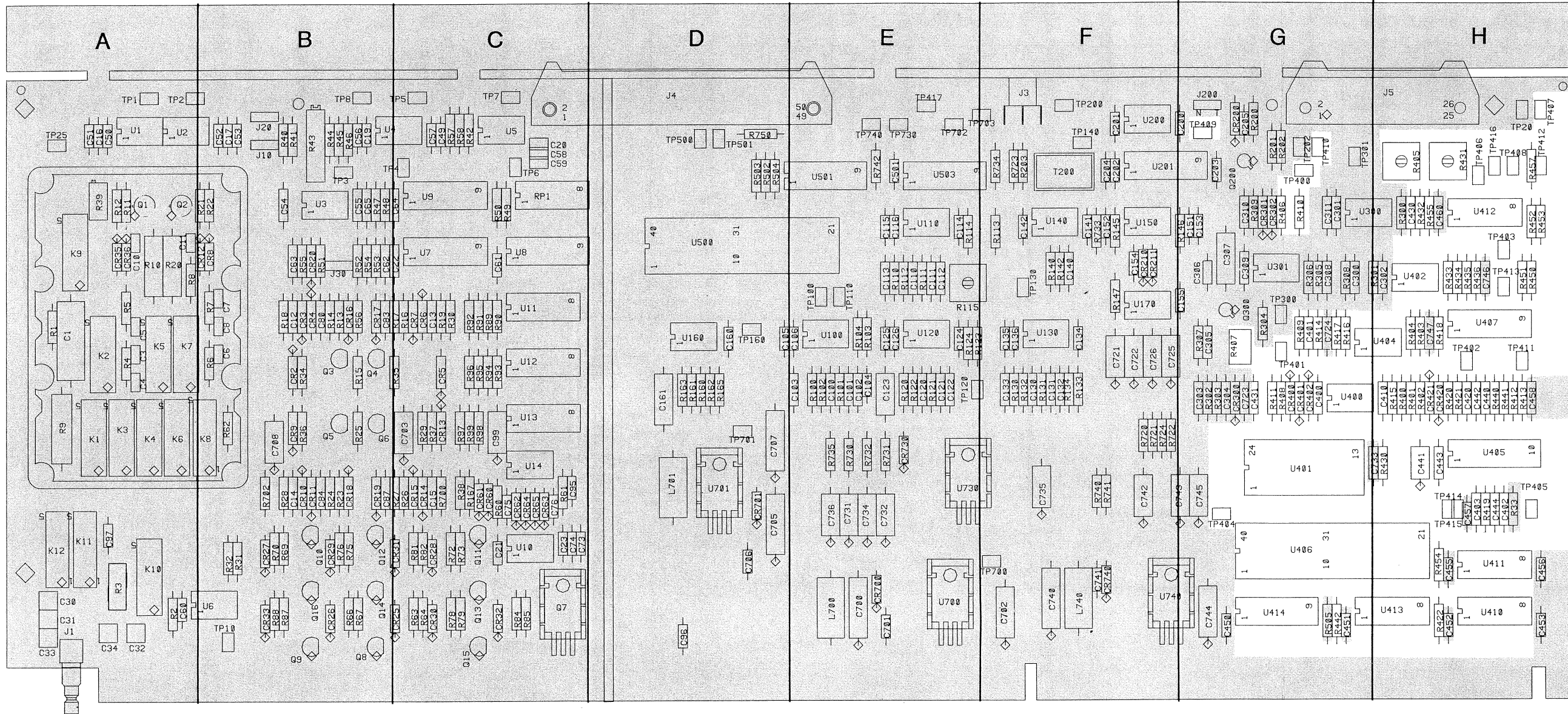

Comp.	Area	Comp.	Area
C400	G	R433	H
C401	G	R434	H
C402	H	R435	H
C403	H	R436	H
C410	H	R440	H
C420	H	R441	H
C430	H	R442	G
C431	G	R450	H
C440	H	R451	H
C441	H	R452	H
C442	H	R453	H
C443	H	R454	H
C444	H	R455	H
CR400	G	R457	H
CR401	G	TP400	G
CR402	G	TP401	G
CR420	H	TP402	H
CR421	H	TP403	H
R400	H	TP404	G
R401	H	TP405	H
R402	H	TP406	H
R403	H	TP407	H
R404	H	TP408	H
R405	H	TP409	G
R406	G	TP410	G
R407	G	TP411	H
R408	G	TP412	H
R409	G	TP413	H
R410	G	TP414	H
R411	G	TP415	H
R412	H	TP416	H
R413	H	U400	G
R414	G	U401	G
R415	H	U402	H
R416	G	U404	H
R417	G	U405	H
R418	H	U406	G
R419	H	U407	H
R420	H	U410	H
R422	H	U411	H
R423	H	U412	H
R430	H	U413	H
R431	H	U414	G
R432	H		

P/O A4 CH 2 INPUT & ADC BOARD
35660-66504 REV B

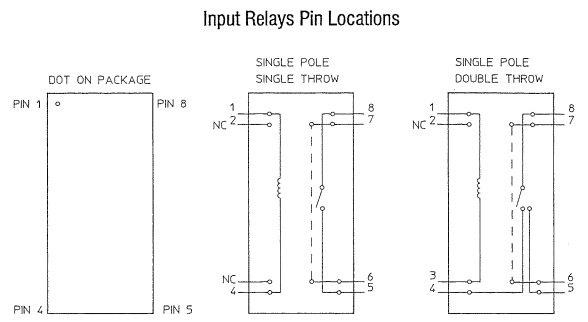

NOTE See back of this foldout for the component locator

RELAY ENERGIZE CIRCUITS

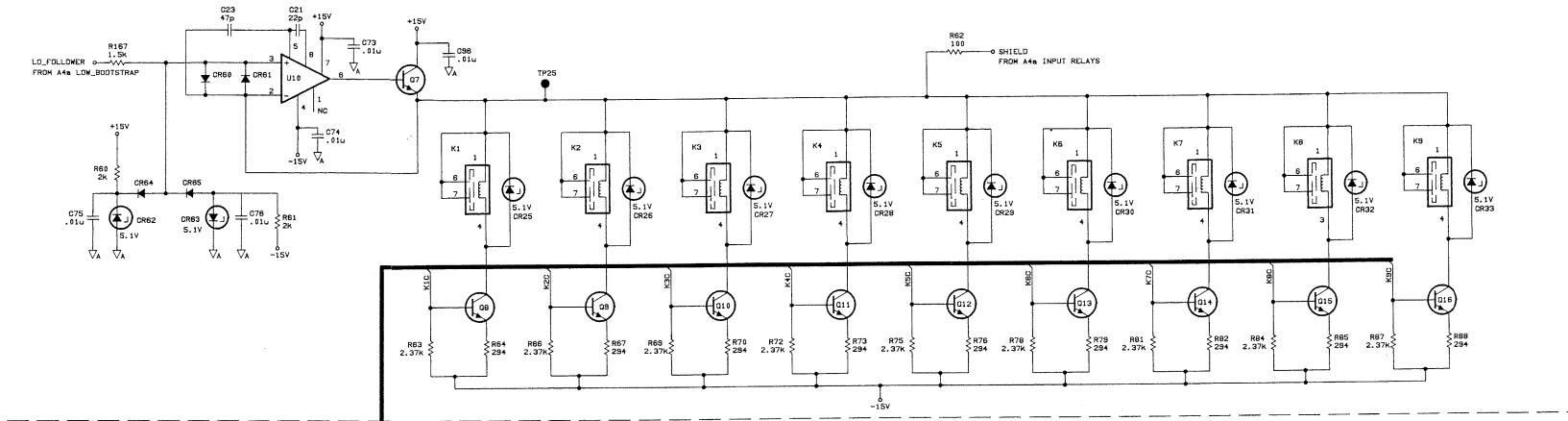

RELAY SELECT LOGIC

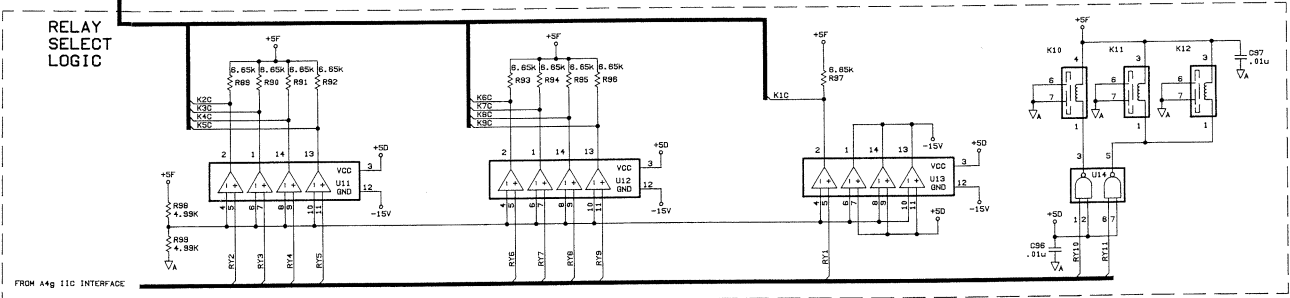

A4f Component Locator

A4f Component Locations

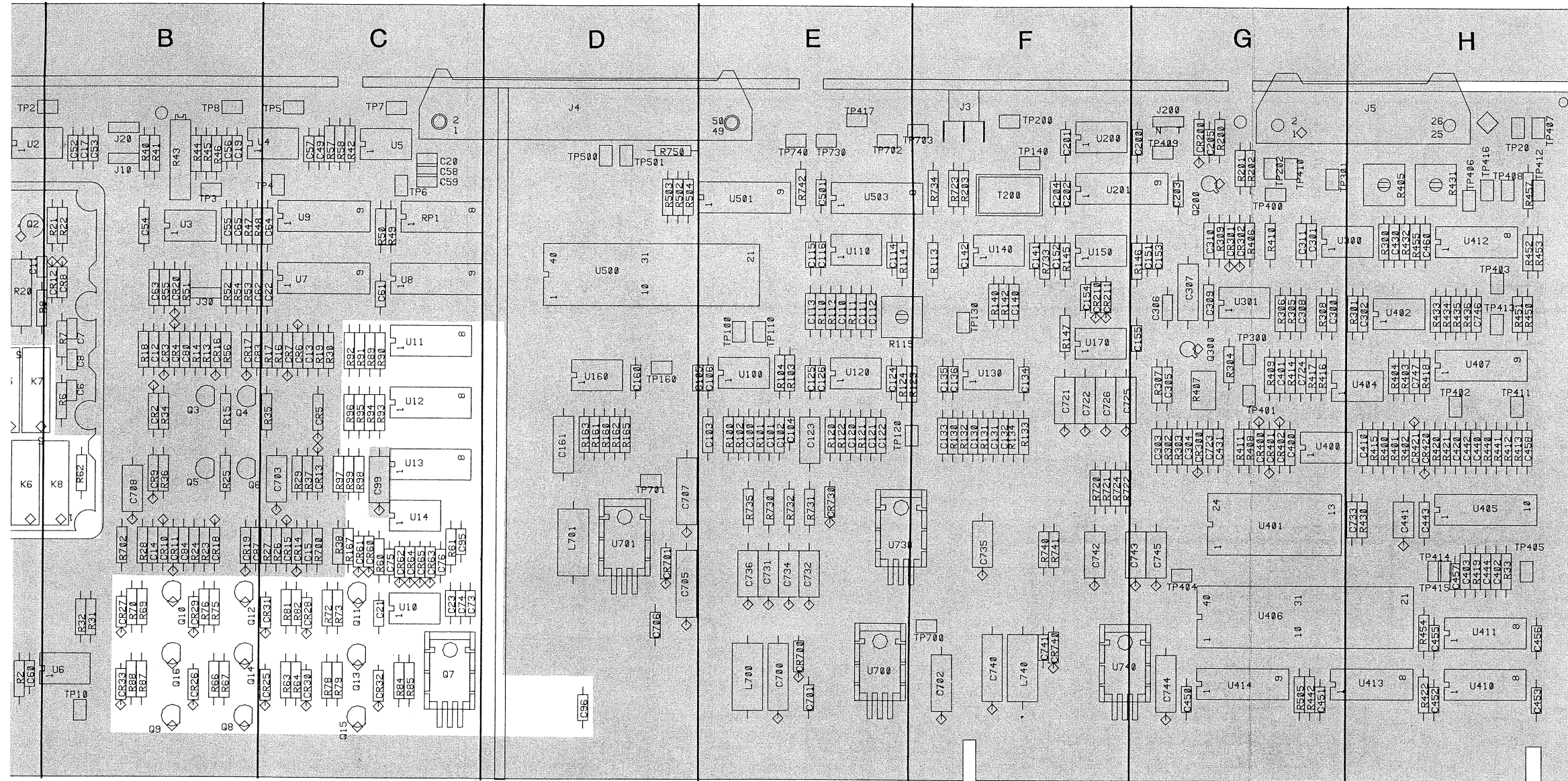

Comp.	Area	Comp.	Area
C021	C	Q014	B
C023	C	Q015	C
C073	C	Q016	B
C074	C	R060	C
C075	C	R061	C
C076	C	R062	B
C095	C	R063	C
C096	D	R064	C
C097	A	R066	B
CR025	C	R067	B
CR026	B	R069	B
CR027	B	R070	B
CR028	C	R072	C
CR029	B	R073	C
CR030	C	R075	B
CR031	C	R076	B
CR032	C	R078	C
CR033	B	R079	C
CR060	C	R081	C
CR061	C	R082	C
CR062	C	R084	C
CR063	C	R085	C
CR064	C	R087	B
CR065	C	R088	B
K001	A	R089	C
K002	A	R090	C
K003	A	R091	C
K004	A	R092	C
K005	A	R093	C
K006	A	R094	C
K007	A	R095	C
K008	B	R096	C
K009	A	R097	C
K010	A	R098	C
K011	A	R099	C
K012	A	R167	C
Q007	C	TP025	A
Q008	B	U010	C
Q009	B	U011	C
Q010	B	U012	C
Q011	C	U013	C
Q012	B	U014	C
Q013	C		

A4g Component Locations

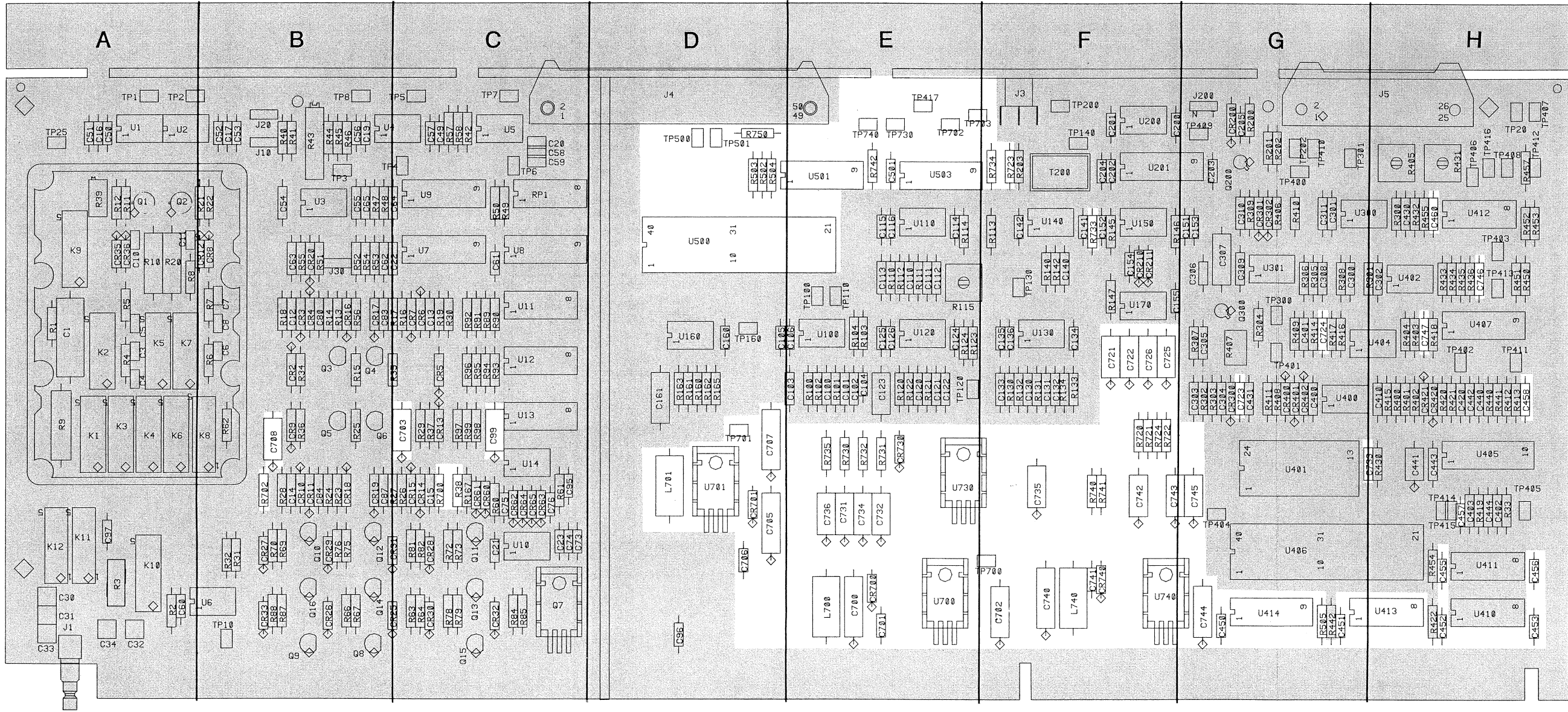

Comp.	Area	Comp.	Area
C099	C	L700	E
C450	G	L701	D
C451	G	L740	F
C452	H	R038	C
C453	H	R502	D
C455	H	R503	D
C456	H	R504	D
C457	H	R505	G
C458	H	R700	C
C460	H	R702	B
C501	E	R720	F
C700	E	R721	F
C701	E	R722	F
C702	F	R723	F
C703	C	R724	F
C705	D	R730	E
C706	D	R731	E
C707	D	R732	E
C708	B	R733	F
C721	F	R734	F
C722	F	R735	E
C723	G	R740	F
C724	G	R741	F
C725	F	R742	E
C726	F	TP417	E
C731	E	TP500	D
C732	E	TP501	D
C733	H	TP700	F
C734	E	TP701	D
C735	F	TP702	E
C736	E	TP703	E
C740	F	TP730	E
C741	F	TP740	E
C742	F	U413	H
C743	G	U414	D
C744	G	U500	D
C745	G	U501	E
C746	H	U503	E
C747	H	U700	E
CR700	E	U701	D
CR701	D	U730	E
CR730	E	U740	F
CR740	F		

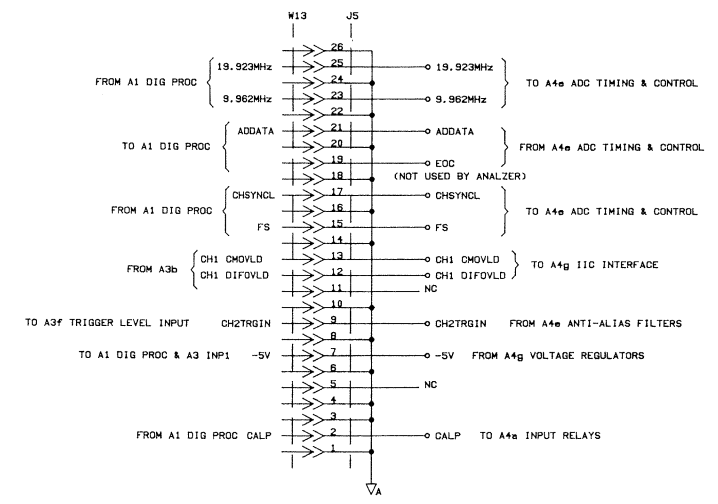
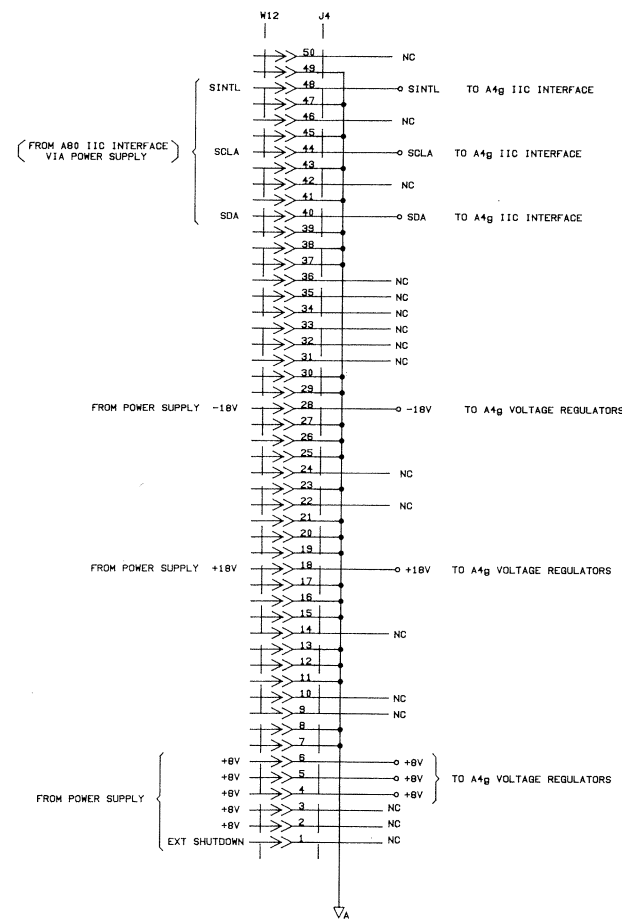

QUICK REFERENCE

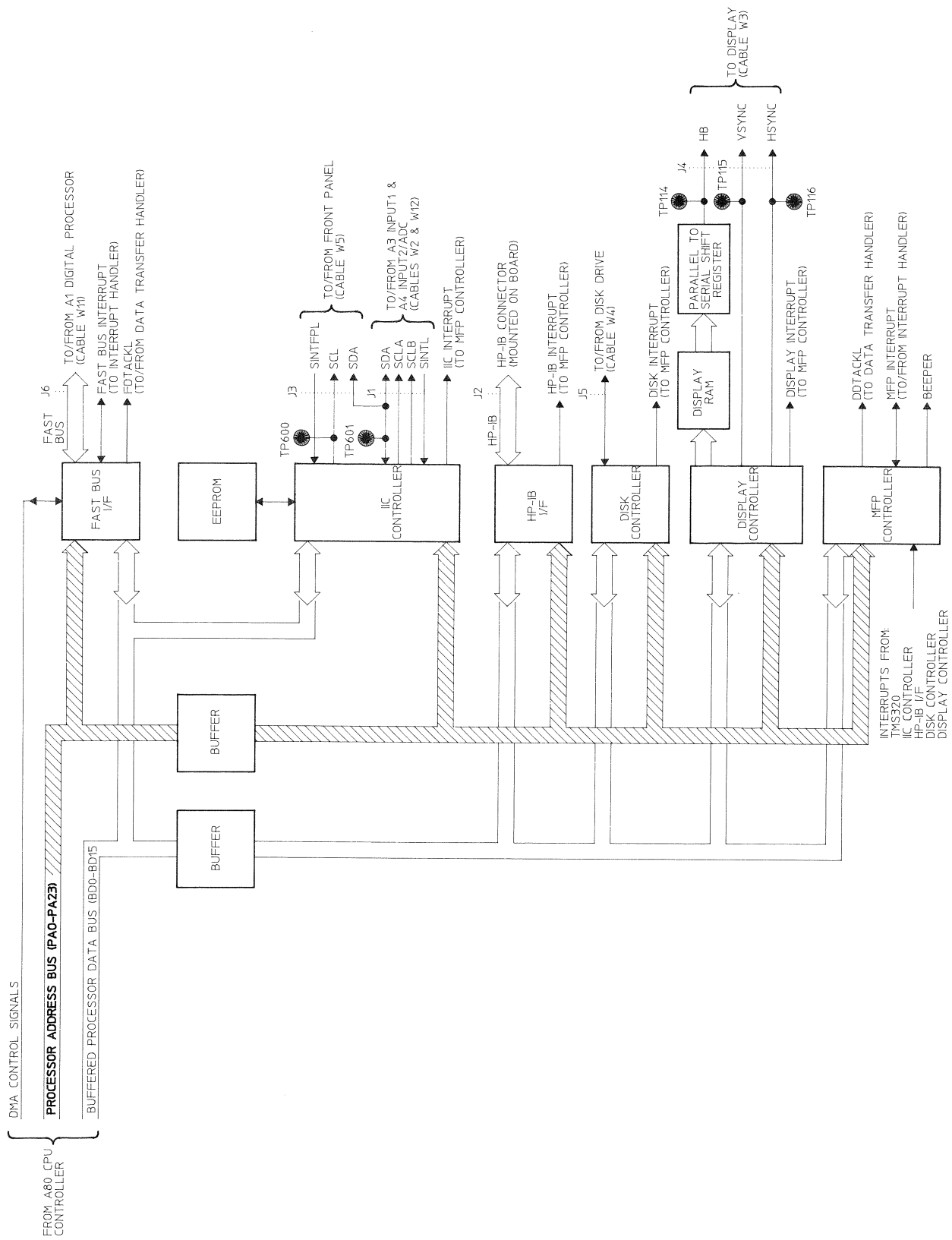

Figure 1. CPU Assembly: Device Interface Block Diagram

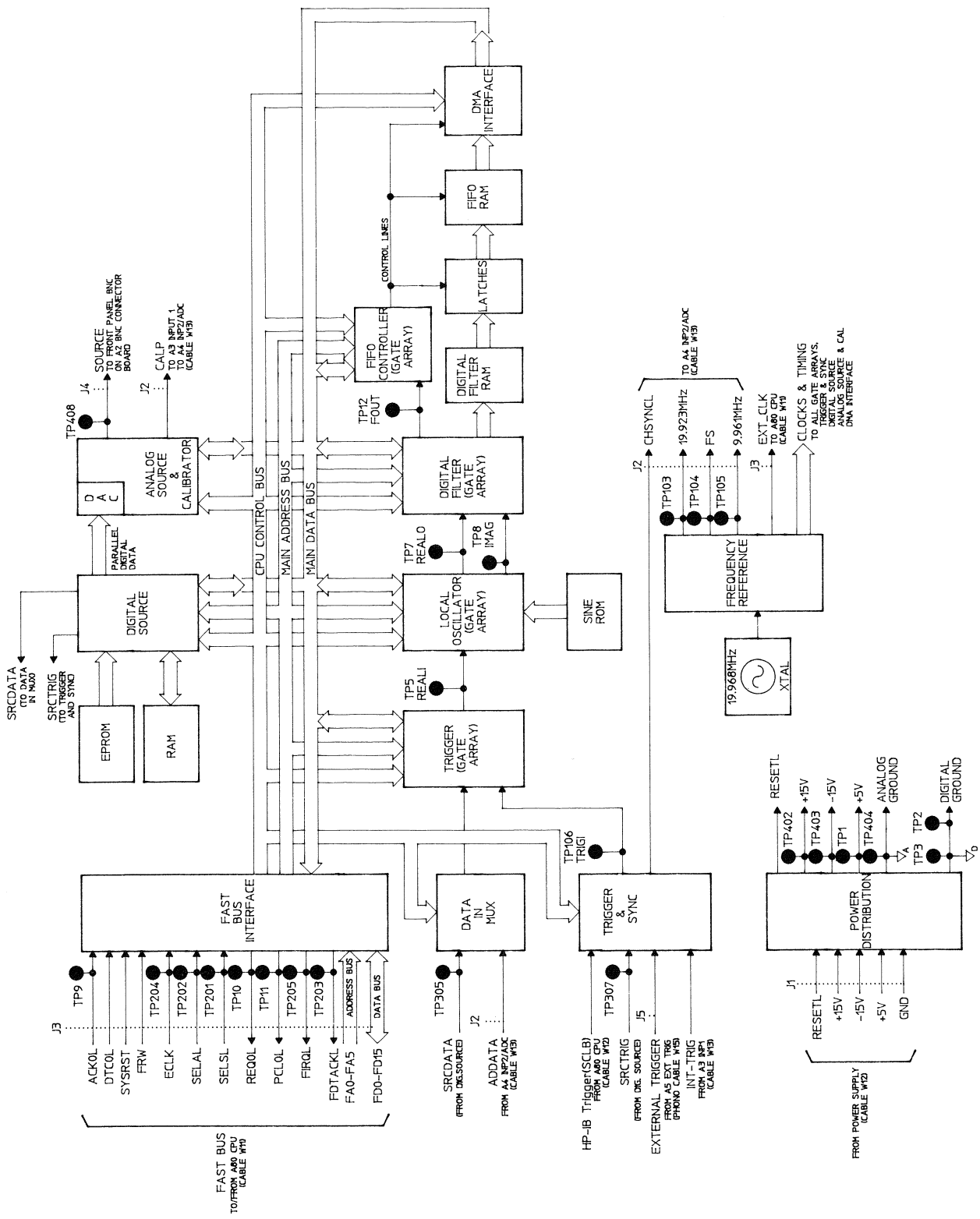
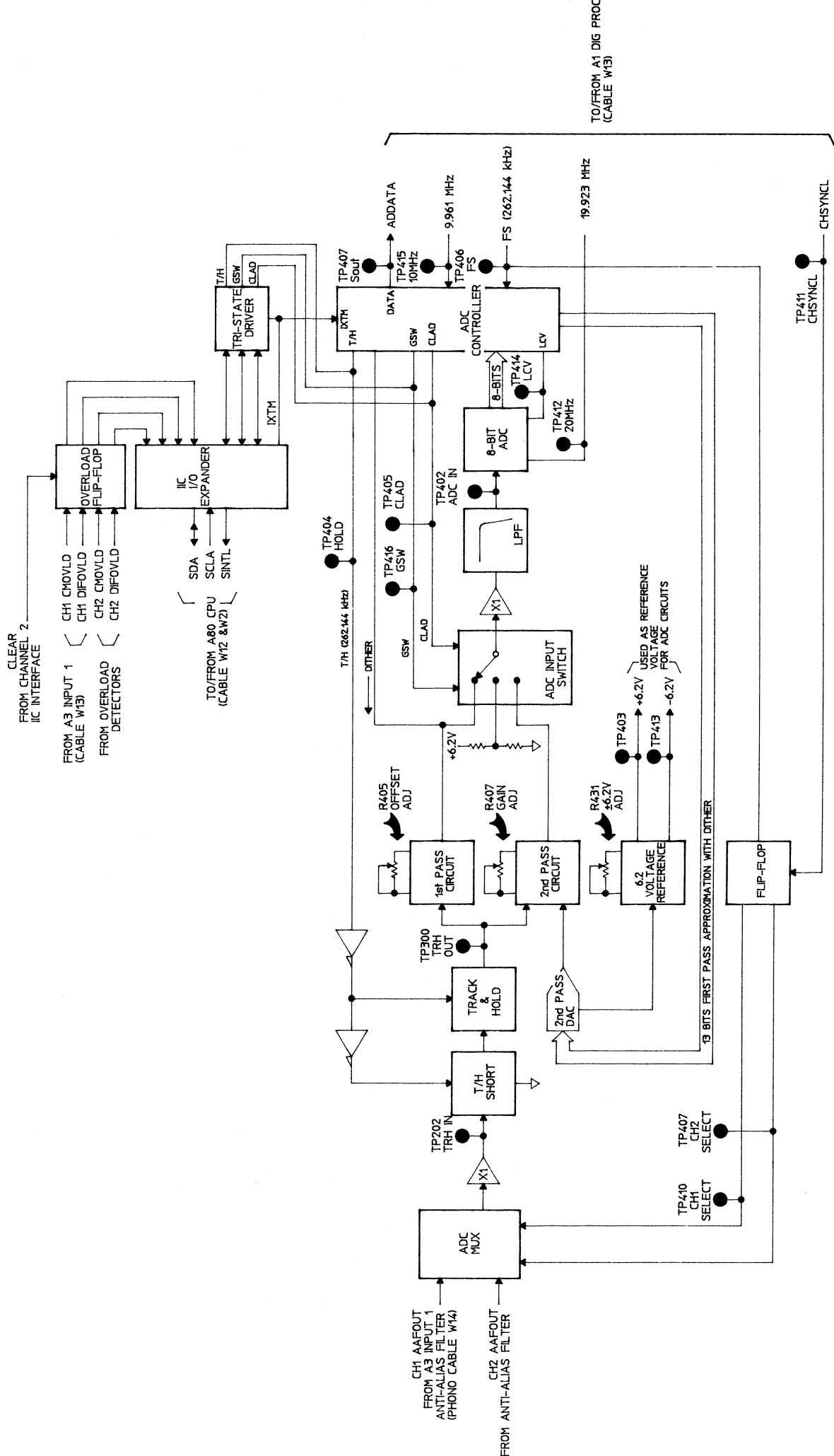

Figure G. Digital Processor Assembly Block Diagram



TO/FROM A1 DIG PROC (CABLE W13)

Figure F. Input 2/ADC: ADC Block Diagram

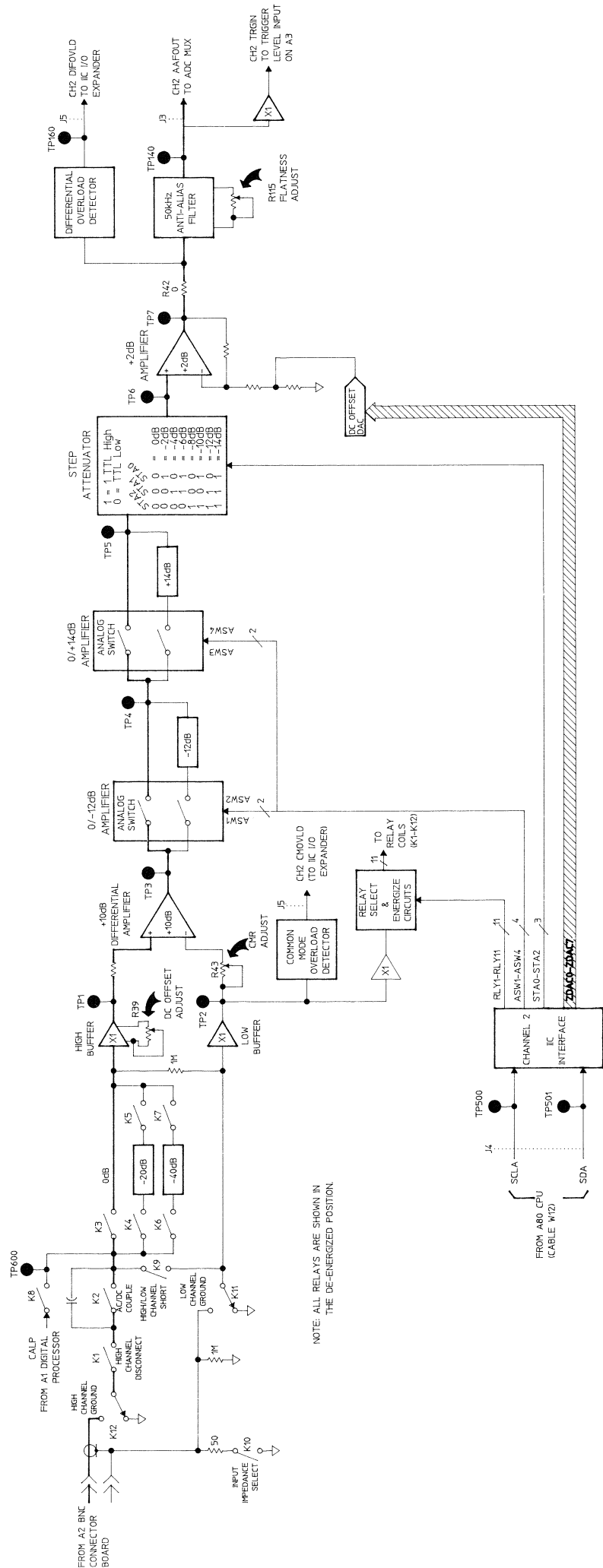

Figure E. Input 2/ADC: Input 2 Block Diagram

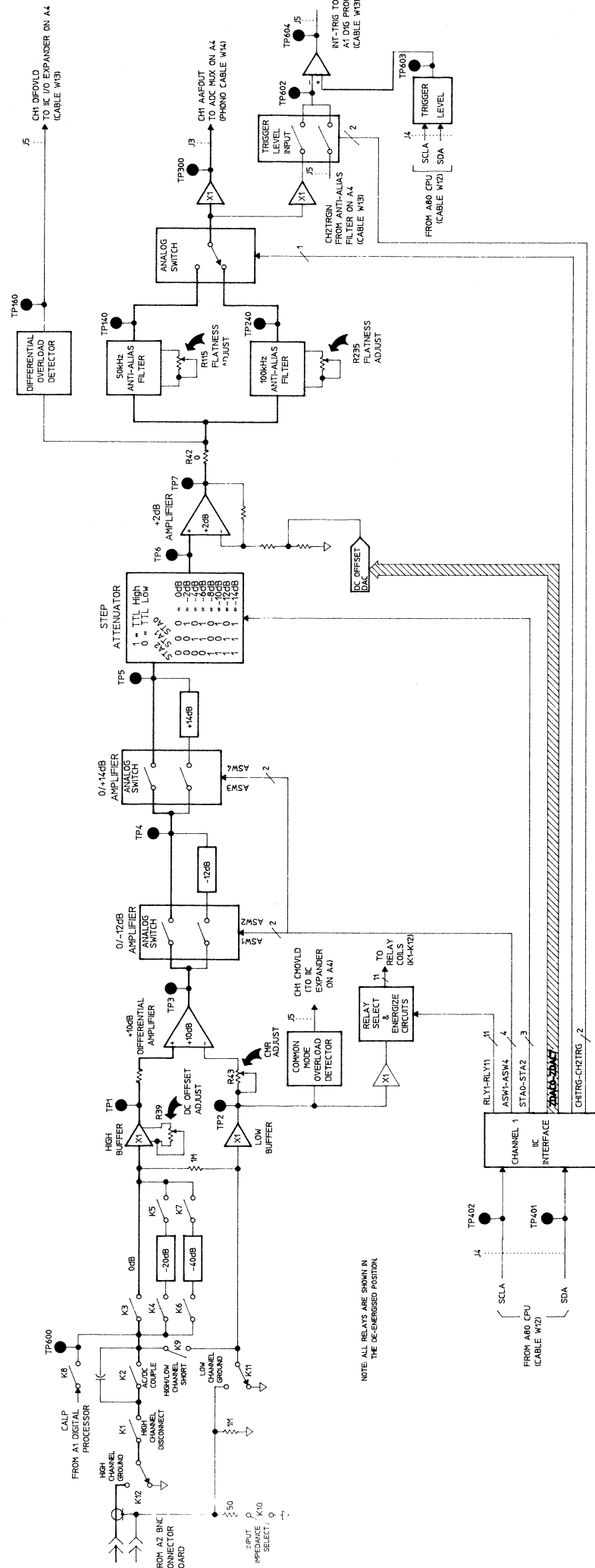

Figure D. Input 1 Assembly Block Diagram

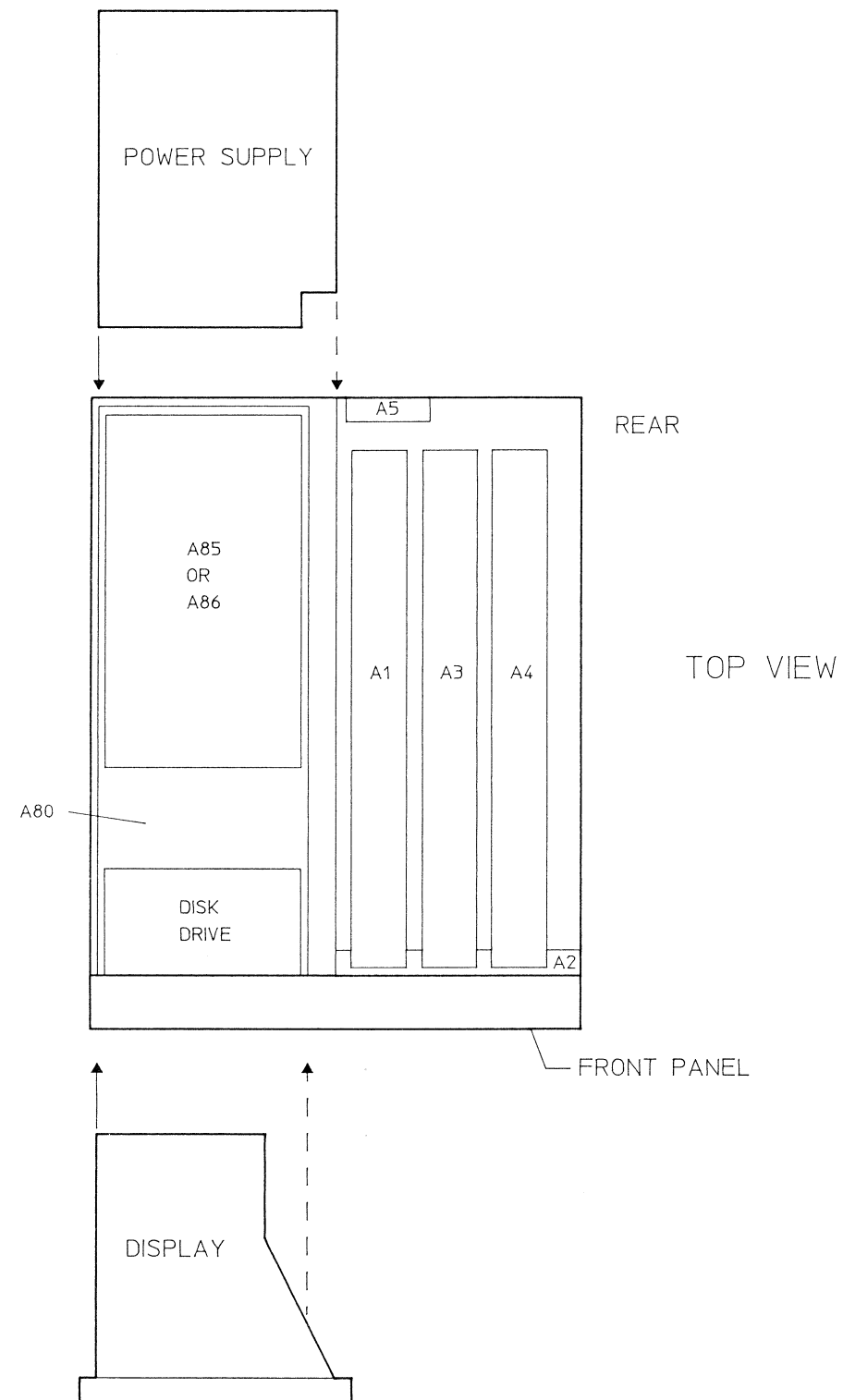
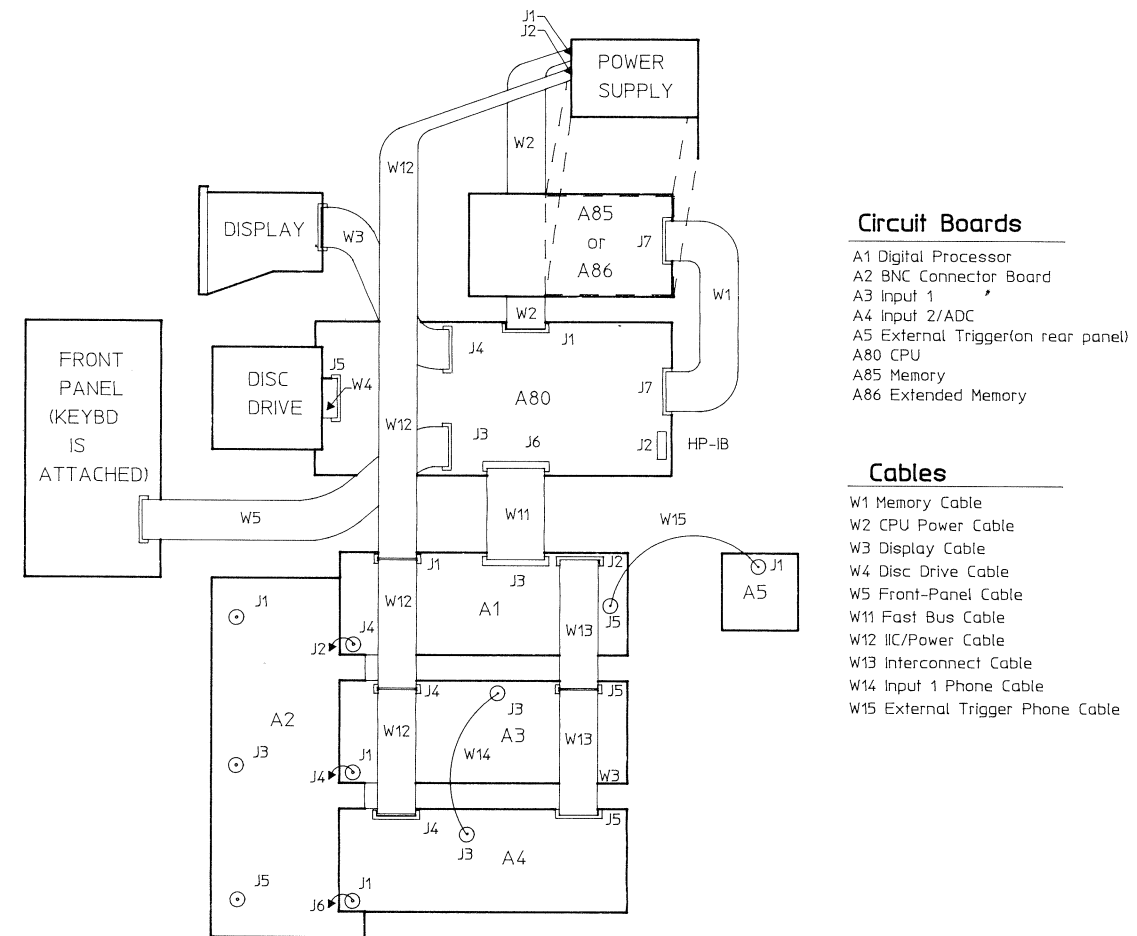

Figure A. Assembly Locations



Circuit Boards

- A1 Digital Processor
- A2 BNC Connector Board
- A3 Input 1
- A4 Input 2/ADC
- A5 External Trigger(on rear panel)
- A80 CPU
- A85 Memory
- A86 Extended Memory

Cables

- W1 Memory Cable
- W2 CPU Power Cable
- W3 Display Cable
- W4 Disc Drive Cable
- W5 Front-Panel Cable
- W11 Fast Bus Cable
- W12 IIC/Power Cable
- W13 Interconnect Cable
- W14 Input 1 Phone Cable
- W15 External Trigger Phone Cable

Figure B. Cable Connections

Note

The Memory Assembly and Expanded Memory Assembly are not repaired to the component level. This component locator is provided for your convenience only. U216 thru U231 are not loaded on the A85 Memory Assembly. They are loaded on the Expanded Memory Assembly

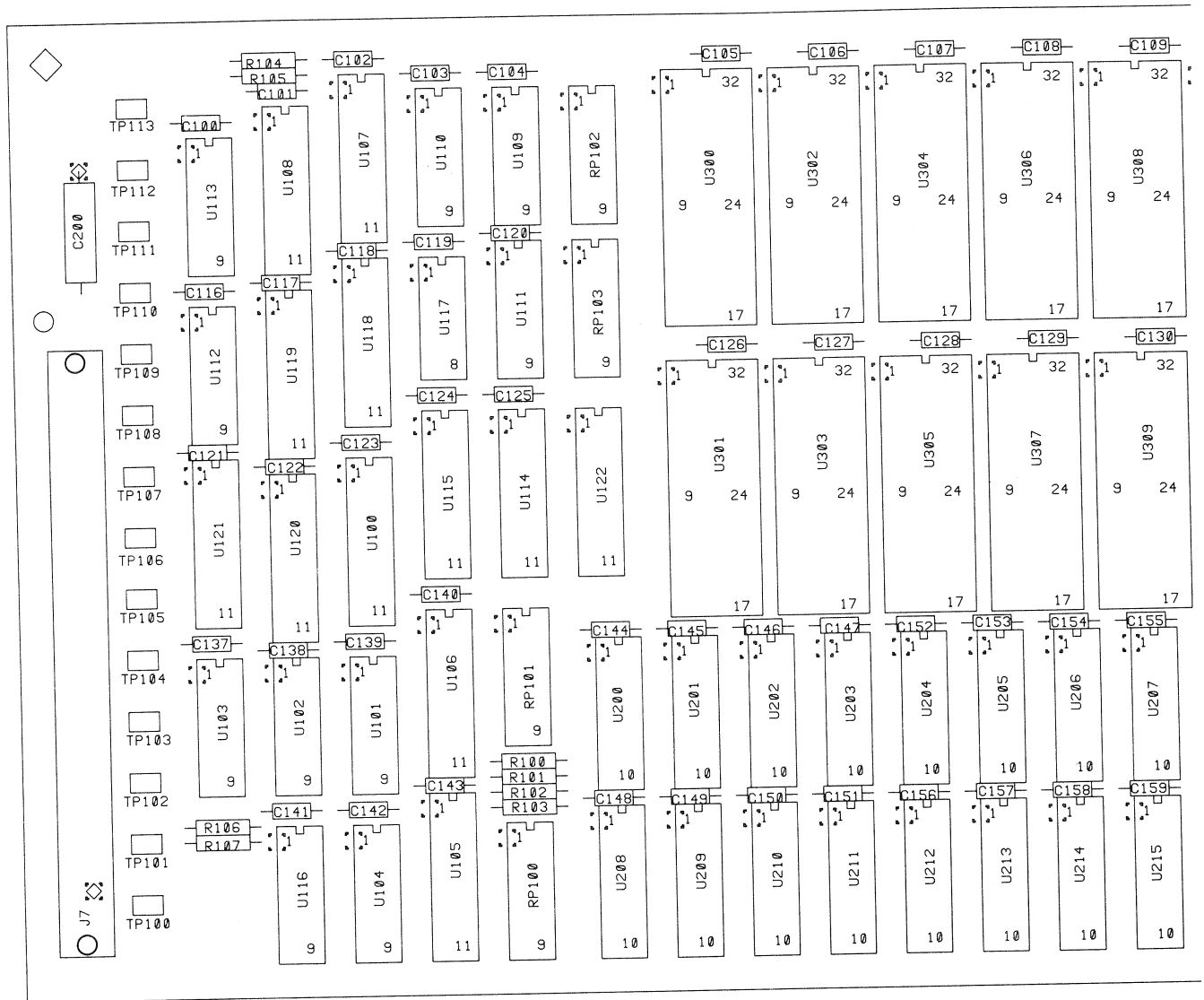

Figure M. P/O Memory Assembly and Expanded Memory Assembly Component Locator

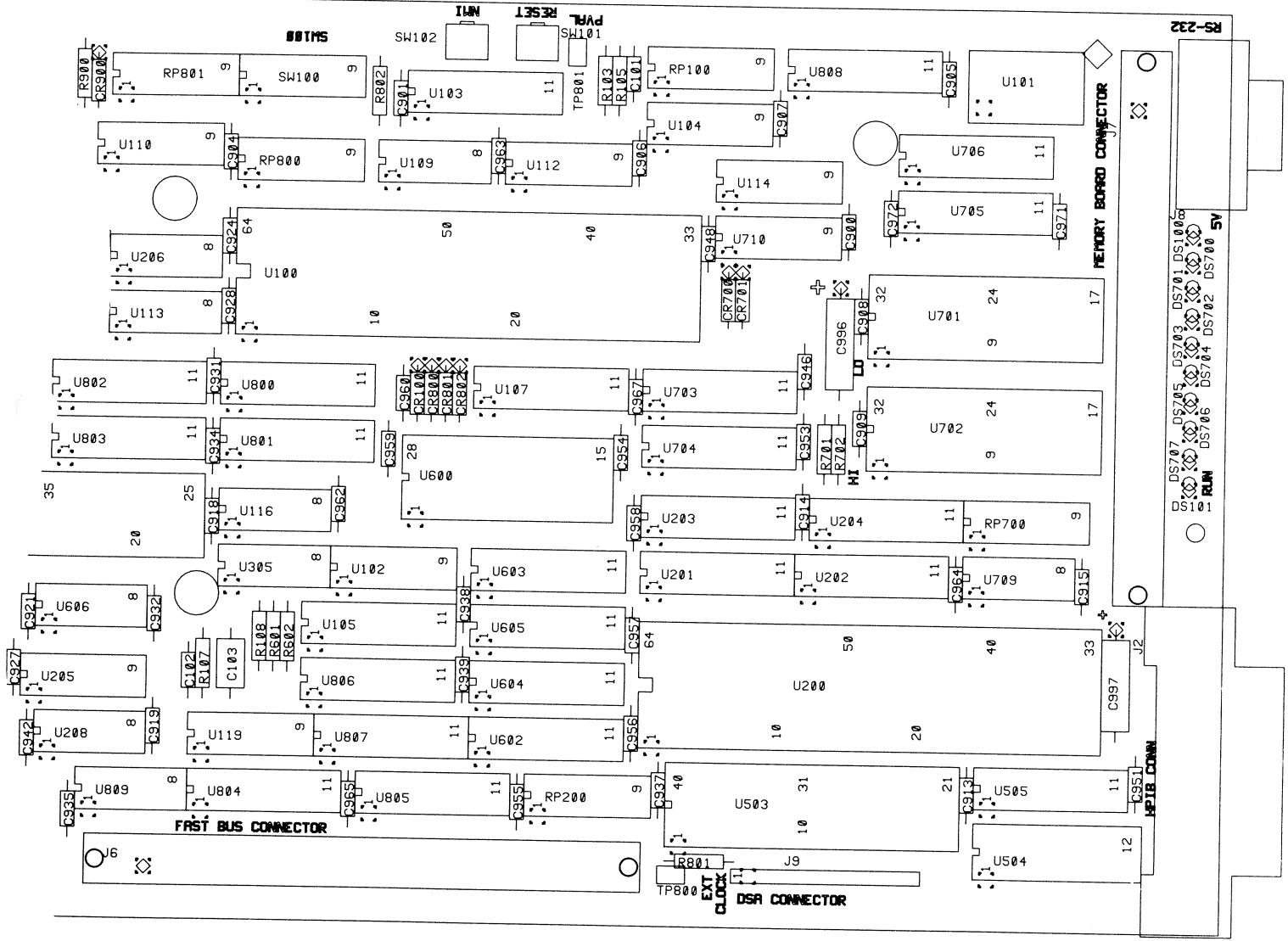

Figure L. P/O CPU Assembly Component Locator

Note

The CPU Assembly is not repaired to the component level. This component locator is provided for your convenience only.

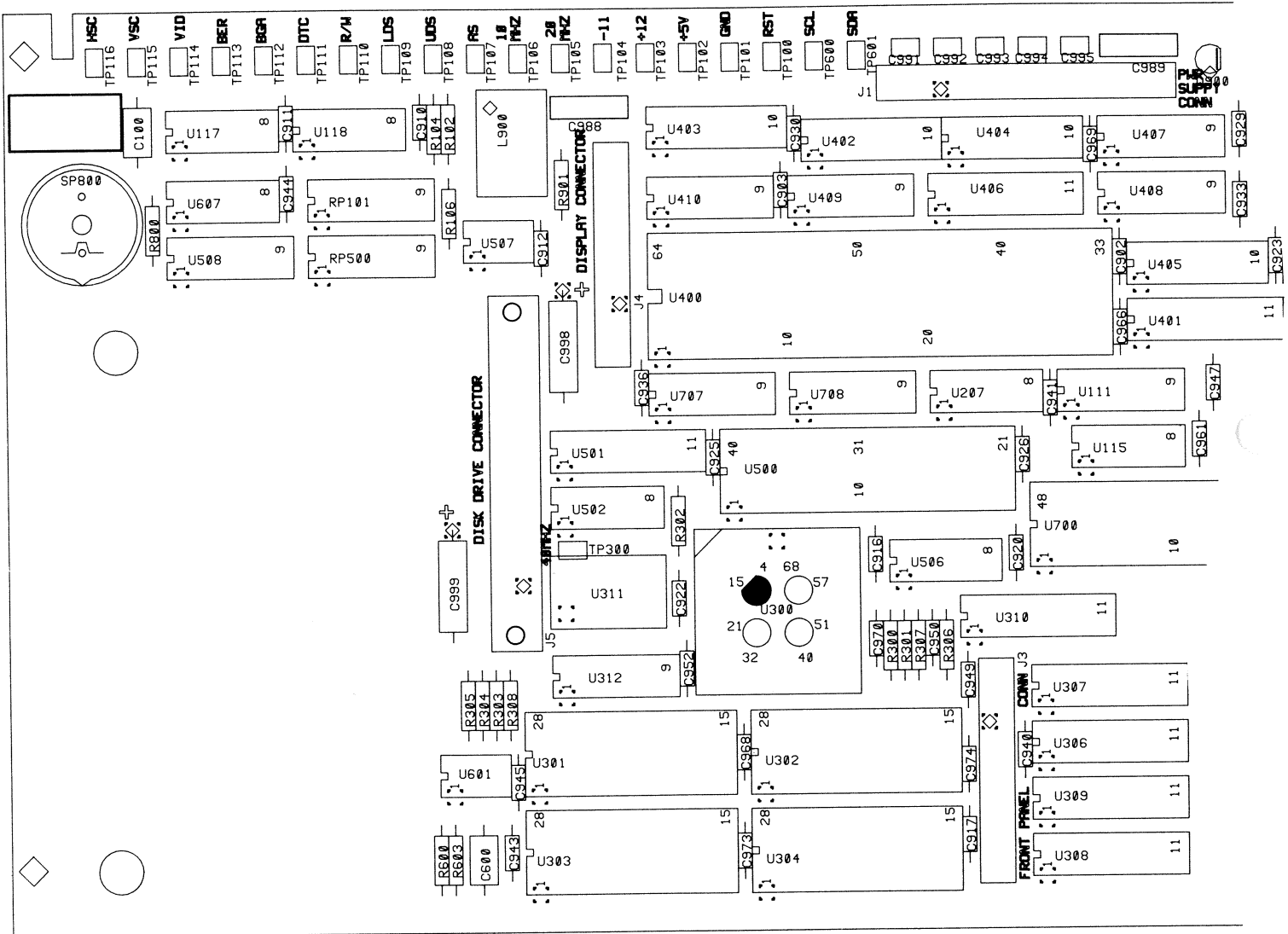

Figure L. P/O CPU Assembly Component Locator

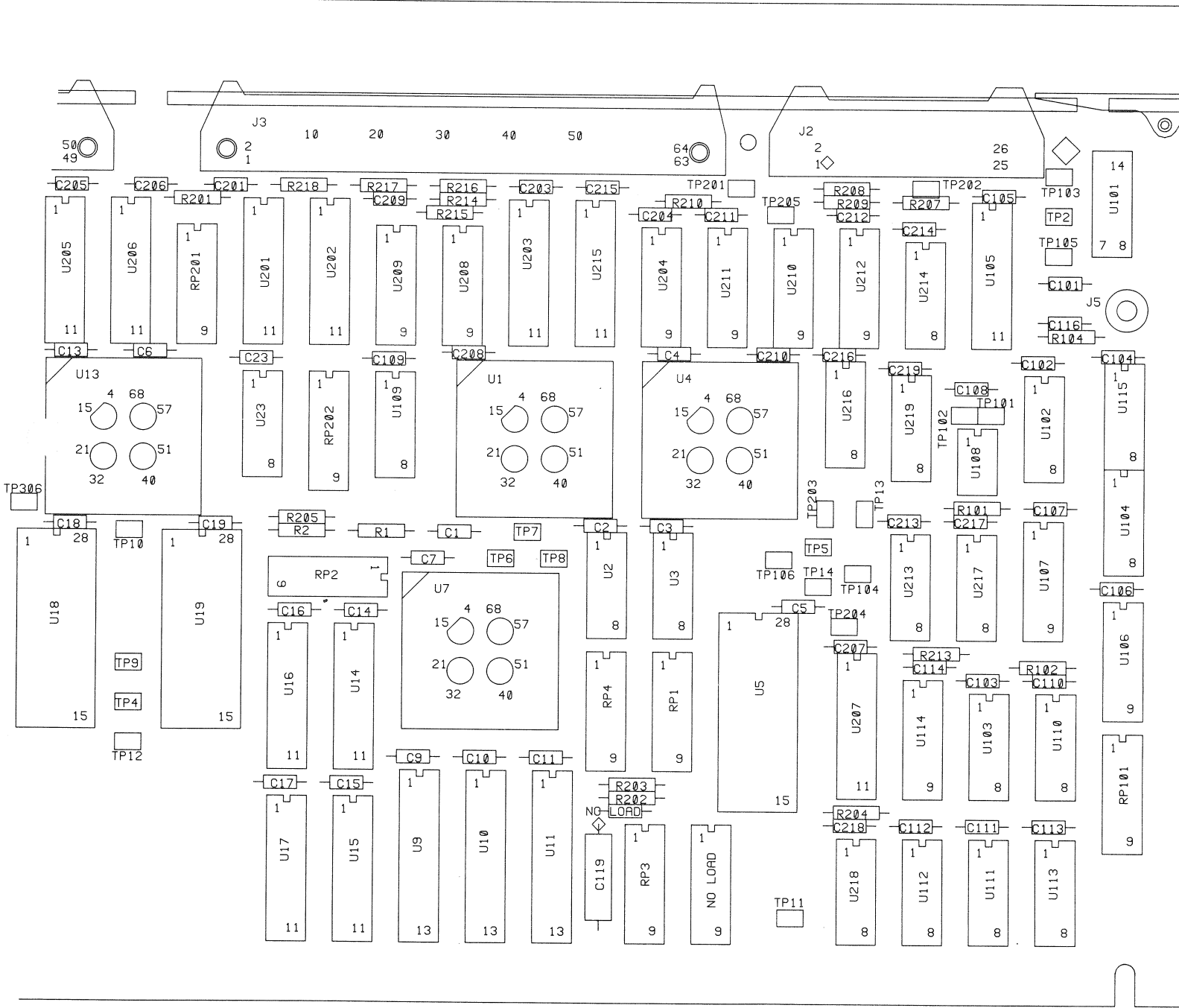

Figure K. P/O Digital Processor Assembly Component Locator

Note

The Digital Processor Assembly is not repaired to the component level. This component locator is provided for your convenience only.

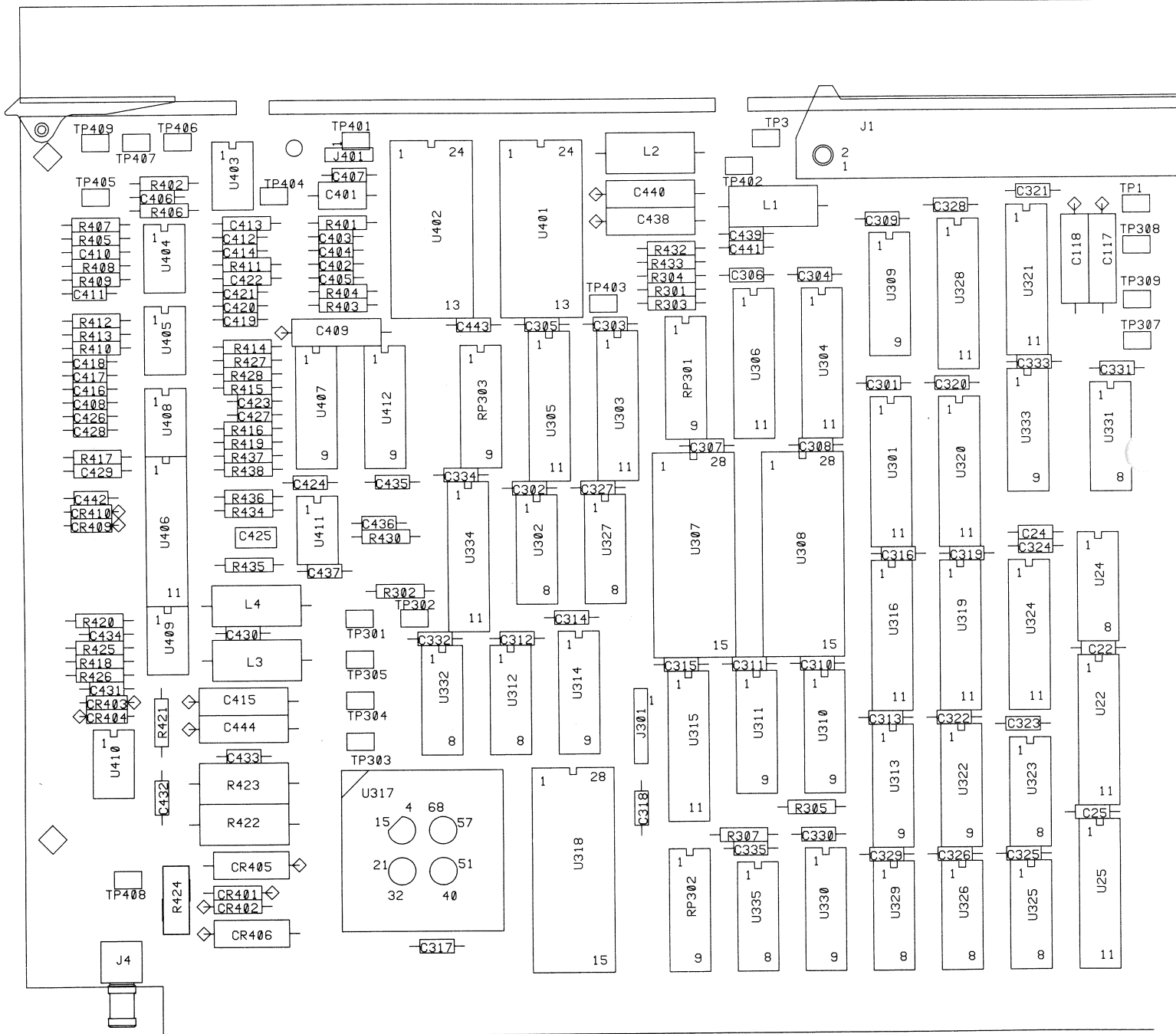

Figure K. P/O Digital Processor Assembly Component Locator

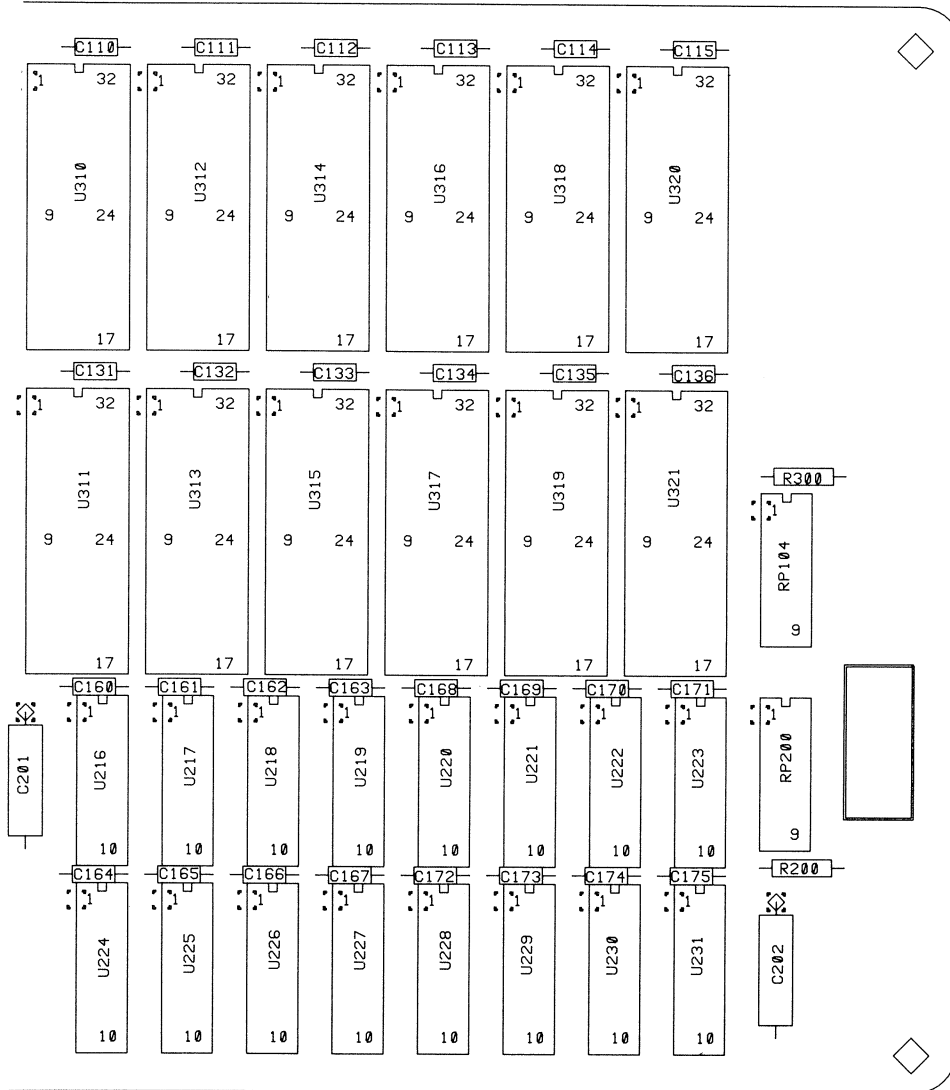

Figure M. P/O Memory Assembly and Expanded Memory Assembly Component Locator

Device-Specific Commands

ARM

subsystem

Description:

This subsystem contains commands and queries related to the analyzer's trigger arming functions. See the TRIG subsystem for commands related to other triggering functions.

ARM[:IMMEDIATE]

command

Overlapped: no
 Delayed result: no
 Pass control required: no
 Power-up state: not applicable

Example Statements: `OUTPUT 711; "ARM"`
`OUTPUT 711; "Arm: Immediate"`

Command Syntax: `ARM[:IMMEDIATE]`

Description:

This command enables triggering when the following two things are true:

- Manual arming is selected.
- Bit 3 of the Device Status condition register (ready-for-arm) is set to 1.

After sending the command, triggering occurs when the appropriate trigger signal is received. The command is ignored when automatic arming is selected.

See ARM:SOUR for more information on arming modes and TRIG:SOUR for information on selecting the trigger signal.

ARM:SOURce[?]**command/query**

Overlapped: no
 Delayed result: no
 Pass control required: no
 Power-up state: FREE

Example Statements: OUTPUT 711;"ARM:SOUR FREE"
 OUTPUT 711;"ARM:SOUR HOLD"
 OUTPUT 711;"Arm:Sour?"

Command Syntax: ARM:SOURce<sp>{FREErun|HOLD}

Query Syntax: ARM:SOURce?

Returned Format: {FREE|HOLD}<LF><^END>

Description:

This command allows you to select one of two modes for arming the trigger. The modes are:

- Automatic arming (ARM:SOUR FREE)
- Manual arming (ARM:SOUR HOLD)

In order for the analyzer to make a measurement, its trigger must be armed before a trigger signal is received. For non-averaged measurements, the trigger must be armed before each measurement. For averaged measurements, the trigger must be armed before each new time record.

When you start a measurement with automatic arming selected, the analyzer waits for the digital filters to settle and then triggers as soon as a trigger signal is received. When the measurement or average is completed, the trigger is automatically re-armed.

When you start a measurement with manual arming selected, the analyzer waits for the digital filters to settle and then waits for you to send the ARM:IMM command. Once both of these conditions are met, the analyzer triggers as soon as a trigger signal is received. When the measurement or average is completed, you must once again send the ARM:IMM command to re-arm the trigger.

The query returns an ASCII string that indicates whether FREErun or HOLD is selected.

See TRIG:SOUR for information on selecting the trigger signal.

AVERage**subsystem****Description:**

This subsystem contains commands related to the analyzer's data averaging functions.

AVER:COUNT[?]**command/query**

Overlapped: no
 Delayed result: yes
 Pass control required: no
 Power-up state: 10

Example Statements: OUTPUT 711; "AVER:COUN 5"
 OUTPUT 711; "Average:Count 100"
 OUTPUT 711; "AVER:COUN?"

Command Syntax: AVERage:COUNT<sp><value>

<value>::=a single integer from 1 to 99999 (NRf format)

Query Syntax: AVERage:COUNT?

Returned Format: <value><LF>< ^ END>

<value>::=a single integer (NR1 format)

Description:

The value sent with this command is used in different ways, depending on the kind of average weighting you have specified. When stable weighting is specified (AVER:WEIG STAB), the value you send with this command determines the number of averages required to complete a measurement. When exponential weighting is specified (AVER:WEIG EXP), the value you send with this command determines two things:

- The number of averages required to complete the first phase of an exponentially averaged measurement
- The weighting factors for new and old data during the second phase of an exponentially averaged measurement

If peak averaging is selected (AVER:TYPE PEAK), or if averaging is turned off (AVER:STAT OFF), the value sent with this command does not affect the measurement.

The value sent with this command affects the setting of the measuring bit in the Device Status condition register. For more information, see Chapter 5, "Using the HP 35660A's Status Registers."

The query returns a value indicating the current number of averages selected.

AVER:DISPlay**selector****Description:**

This command only selects the AVER:DISP subsystem. Sending AVER:DISP alone does nothing.

AVER:DISP:RATE[?]**command/query**

Overlapped: no
 Delayed result: yes
 Pass control required: no
 Power-up state: 5

Example Statements: OUTPUT 711;"aver:disp:rate 10"
 OUTPUT 711;"AVERAGE:DISPLAY:RATE 5"
 OUTPUT 711;"AVER:DISP:RATE?"

Command Syntax: AVERage:DISPlay:RATE<sp> <value>
 <value> ::= a single integer from 1 to 99999 (NRf format)

Query Syntax: AVERage:DISPlay:RATE?

Returned Format: <value><LF>< ^ END>
 <value> ::= a single integer (NR1 format)

Description:

When fast averaging is turned on (AVER:DISP:RATE:STAT ON) you can specify an interval for display updates. This is the command you use to specify that interval. For example, if you send AVER:DISP:RATE 5, the display is updated once every 5 averages.

The value specified with this command is not used if fast averaging is turned off (AVER:DISP:RATE:STAT OFF).

The query returns a value that indicates the current display update rate.

AVER:DISP:RATE:STATe[?]**command/query**

Overlapped: no
 Delayed result: yes
 Pass control required: no
 Power-up state: 0

Example Statements: OUTPUT 711;"AVER:DISP:RATE:STAT 1"
 OUTPUT 711;"Average:Display:Rate:State Off"
 OUTPUT 711;"aver:disp:rate:stat?"

Command Syntax: AVERage:DISPlay:RATE:STATe<sp>{OFF|ON|0|1}

Query Syntax: AVERage:DISPlay:RATE:STATe?

Returned Format: {0|1}<LF><^END>

Description:

Use this command to turn fast averaging off and on. When fast averaging is off, the display is updated each time one average is taken.

When fast averaging is on, the display is updated each time a specified number of averages is taken. The number can be from 1 to 99,999 and is specified with the AVER:DISP:RATE command. For example, if fast averaging is on (AVER:DISP:RATE:STAT ON), and the value of AVER:DISP:RATE is 5, the display is updated every 5 averages. If the number specified in AVER:DISP:RATE is larger than the number of averages required to complete your measurement, the display is only updated when the measurement is paused or completed.

The query returns 0 if fast averaging is off, 1 if it is on.

AVER:INITialize**command**

Overlapped: no
 Delayed result: yes
 Pass control required: no
 Power-up state: not applicable

Example Statements: OUTPUT 711;"Aver:Init"
 OUTPUT 711;"AVERAGE:INITIALIZE"

Command Syntax: AVERage:INITialize

Description:

This command sets a flag so that the next INIT:STAT RUN command will start a new running average. For example, if a measurement is paused and you send AVER:INIT followed by INIT:STAT RUN, a new running average is started after the old one is discarded. However, if a measurement is paused and you only send INIT:STAT RUN, the paused measurement continues from where it was stopped and new data is averaged in with the old running average.

AVER:OVERlap[?]**command/query**

Overlapped: no
 Delayed result: yes
 Pass control required: no
 Power-up state: 0

Example Statements: OUTPUT 711;"AVER:OVER .1"
 OUTPUT 711;"average:overlap 90PCT"
 OUTPUT 711;"AVERAGE:OVERLAP?"

Command Syntax: AVERAge:OVERlap<sp>{{<percent>PCT}|<fraction>}
 <percent>::=an integer from 0 to 99 (NRf format)
 <fraction>::=a decimal number from .00 to .99 in increments of .01 (NRf format)

Query Syntax: AVERAge:OVERlap?

Returned Format: <fraction><LF><^END>
 <fraction>::=a decimal number (NR2 format)

Description:

Under certain conditions, data points from the end of one time record can be reused at the beginning of the next time record. This results in the overlapping of time records. Use the AVER:OVER command to specify the maximum amount of time record overlap you want to allow.

Overlapping becomes possible when the instrument takes more time to collect time records than it does to process them. This occurs at narrower frequency spans. At spans narrow enough to allow the requested amount of overlapping, time records will be overlapped.

You can specify overlap either as a percentage or as a fraction of the time record length. AVER:OVER 22PCT is the same as AVER:OVER 0.22. In either case, the value you send is rounded to the nearest allowable percentage (an integer between 0 and 99). You can step the current overlap setting up or down 1% by sending AVER:OVER UP or AVER:OVER DOWN.

The query returns a value that indicates the amount of overlap currently specified. The value is returned in fractional form.

AVER[:STATe][?]**command/query**

Overlapped: no
 Delayed result: yes
 Pass control required: no
 Power-up state: 0

Example Statements: OUTPUT 711;"AVER OFF"
 OUTPUT 711;"AVERAGE:STATE 1"
 OUTPUT 711;"Aver?"

Command Syntax: AVERage[:STATe]<sp>{OFF|ON|0|1}

Query Syntax: AVERage[:STATe]?

Returned Format: {0|1}<LF>< ^END>

Description:

Use this command to turn averaging off and on.

The query returns 0 if averaging is off, 1 if averaging is on.

See the following for more information:

- AVER:TYPE – for selecting an averaging type.
- AVER:WEIG – for specifying how averaged data should be weighted.
- AVER:COUN – for specifying the number of averages

AVER:TYPE[?]**command/query**

Overlapped: no
 Delayed result: yes
 Pass control required: no
 Power-up state: RMS

Example Statements: OUTPUT 711;"AVER:TYPE RMS"
 OUTPUT 711;"Average:Type Peak"
 OUTPUT 711;"Aver:Type?"

Command Syntax: AVERage:TYPE<sp>{PEAK|RMS|VECTor}

Query Syntax: AVERage:TYPE?

Returned Format: {PEAK|RMS|VECT}<LF>< ^ END>

Description:

This is one of two commands that affect the way running averages of measurement data are calculated. The other command is AVER:WEIG.

You can specify one of three options with this command:

- Rms – root mean square averaging of the last n power spectra or linear averaging of the last n cross spectra
- Vector – vector averaging of the last n linear spectra
- Peak hold – point by point maximum of the last n power spectra, not available for cross spectra

With rms averaging selected (AVER:TYPE RMS), you get a good approximation all input signal components, including noise. Each frequency bin is averaged separately.

With vector averaging (AVER:TYPE VECT) and an appropriate trigger source selected, noise components tend to cancel. This allows you to resolve smaller periodic signals. Each frequency bin is averaged separately.

With peak hold selected (AVER:TYPE PEAK), the peak value for each frequency bin is retained each time a new power spectrum is acquired. The value of AVER:COUN is not used to stop the acquisition of new spectra, so they are acquired continuously until the measurement is paused.

When stable weighting is selected, rms and vector averaging stop when the specified number of averages is acquired. When exponential weighting is selected, rms and vector averaging continue indefinitely until the measurement is paused.

The query response indicates which type of averaging is currently selected.

AVER:WEIGHting[?]**command/query**

Overlapped: no
 Delayed result: yes
 Pass control required: no
 Power-up state: STAB

Example Statements: OUTPUT 711;"aver:weig stab"
 OUTPUT 711;"Average:Weighting Exponential"
 OUTPUT 711;"AVER:WEIG?"

Command Syntax: AVERage:WEIGHting<sp> {EXPonential|STABle}

Query Syntax: AVERage:WEIGHting?

Returned Format: {EXP|STAB}<LF>< ^ END>

Description:

This command allows you to specify how averaged data will be weighted. The options are:

- Stable (or uniform) weighting (AVER:WEIG STAB)
- Exponential weighting (AVER:WEIG EXP)

With stable averaging selected, each spectrum included in the running average is weighted equally. Also, the measurement stops when the specified number of averages has been acquired.

With exponential averaging selected, there are two distinct phases to the averaging process. During the first phase, each spectrum included in the running average is weighted equally, as in stable averaging. During the second phase, new and old data are weighted as follows:

$$[(1/N) \times \text{new}] + [(N-1)/N \times \text{old}]$$

Where: N is the value of AVER:COUN (number of averages)
 new is the most recently acquired spectrum
 old is the data in the running average

The first phase of an exponentially averaged measurement continues until the running average includes the number of spectra specified in AVER:COUN (number of averages). The second phase continues indefinitely until the measurement is paused.

The setting of AVER:WEIG is not used if peak hold averaging (AVER:TYPE PEAK) is selected.

The query returns a mnemonic that indicates the type of weighting selected: EXP for exponential or STAB for stable weighting.

CALibration**subsystem****Description:**

This subsystem contains commands related to calibration of the analyzer.

CAL[:ALL]?**query**

Overlapped: no
 Delayed result: no
 Pass control required: no
 Power-up state: not applicable

Example Statement: OUTPUT 711;"CAL?"

Query Syntax: CALibration[:ALL]?

Returned Format: <value><LF>< ^END>

 <value>::=an integer (NR1 format)

Description:

The instrument performs a full calibration when you send this query. The query response is a 0 if the calibration is successful. The response is a non-zero integer if the calibration fails, with the integer being an error number.

The calibration routine performed when you send this query is the same as the calibration routine performed when you send the CAL:SING command.

CAL:AUTO[?]**command/query**

Overlapped: no
 Delayed result: yes
 Pass control required: no
 Power-up state: 1

Example Statements: OUTPUT 711;"CAL:AUTO OFF"
 OUTPUT 711;"calibration:auto 1"
 OUTPUT 711;"Cal:Auto?"

Command Syntax: CALibration:AUTO<sp>{OFF|ON|0|1}

Query Syntax: CALibration:AUTO?

Returned Format: {0|1}<LF>< ^ END>

Description:

Use this command to enable and disable the analyzer's autocalibration routine. The routine causes the analyzer to calibrate automatically at power-up, several times during the first hour of operation, and once each hour after that.

NOTE The autocalibration routine does not interrupt an averaged measurement in progress.

When you turn autocalibration off (CAL:AUTO OFF), the analyzer is only recalibrated when you send the CAL:SING command or the CAL:ALL query. Calibration always occurs automatically at power-up.

The query returns 0 if autocalibration is disabled, 1 if it is enabled.

CAL:CLEar**command**

Overlapped: no
 Delayed result: yes
 Pass control required: no
 Power-up state: not applicable

Example Statements: OUTPUT 711;"Cal:Cle"
 OUTPUT 711;"CALIBRATION:CLEAR"

Command Syntax: CALibration:CLEar

Description:

This command clears all calibration constants until the next calibration occurs. While the calibration constants are cleared, data from the current measurement is uncalibrated.

If autocalibration is enabled (CAL:AUTO ON), the calibration constants can remain cleared for as long as one hour. If autocalibration is disabled, the constants remain cleared until you send CAL:ALL? or CAL:SING.

Bit 2 of the Data Integrity Condition register indicates whether or not the calibration constants are currently cleared.

CAL:SINGle**command**

Overlapped: yes
 Delayed result: no
 Pass control required: no
 Power-up state: not applicable

Example Statements: OUTPUT 711;"CAL:SING"
 OUTPUT 711;"Calibration:Single"

Command Syntax: CALibration:SINGle

Description:

This command causes the analyzer to recalibrate immediately. The calibration occurs whether the autocalibration routine is enabled or disabled (CAL:AUTO ON or OFF). The analyzer's measurement activities are suspended during the calibration.

CAL:TRACe[?]**command/query**

Overlapped: no
Delayed result: yes
Pass control required: no
Power-up state: 0

Example Statements: OUTPUT 711;"CAL:TRAC 1"
OUTPUT 711;"Calibration:trace OFF"
OUTPUT 711;"CAL:TRAC?"

Command Syntax: CALibration:TRACe<sp>{OFF|ON|0|1}

Query Syntax: CALibration:TRACe?

Returned Format: {0|1}<LF><^END>

Description:

This command allows you to display the calibration constants that will be used for a particular measurement setup. To display the constant for a setup, you must do all of the following:

1. Specify the measurement setup
2. send CAL:TRAC ON
3. send INIT:STAT STAR

The query returns 0 if the calibration constants are not being displayed, 1 if they are.

CONFigure**subsystem**

Description:

The single command in this subsystem is used to switch the analyzer between its one-channel and two-channel operating modes.

CONF:TYPE[?]**command/query**

Overlapped: no
 Delayed result: yes
 Pass control required: no
 Power-up state: SPEC

Example Statements: OUTPUT 711;"conf:type spec"
 OUTPUT 711;"CONFIGURE:TYPE NETWORK"
 OUTPUT 711;"Conf:Type?"

Command Syntax: CONFigure:TYPE<sp>{NETWork|SPECtrum}

Query Syntax: CONFigure:TYPE?

Returned Format: {NETW|SPEC}<LF>< ^ END>

Description:

Use this command to select the analyzer's one-channel or two-channel operating mode.

The one-channel mode is selected with CONF:TYPE SPEC. In this mode, channel 1 can analyze signal components up to 102.4 kHz. Channel 2 is not used at all. The following data can be displayed in this mode:

- Channel 1 time (TRAC:RES TIME1)
- Channel 1 spectrum, linear or power (TRAC:RES SPEC1)
- Channel 1 power spectral density (TRAC:RES PSD1)
- Functions 1-5 (TRAC:RES F1-5)
- Constants 1-5 (TRAC:RES K1-5)
- Recalled traces (MMEM:LOAD:TRAC <file_spec>)

The two-channel mode is selected with CONF:TYPE NETW. In this mode, channels 1 and 2 can both analyze signal components up to 51.2 kHz. When this mode is selected, all data available in the one-channel mode and the following additional data can be displayed:

- Channel 2 time (TRAC:RES TIME2)
- Channel 2 spectrum, linear or power (TRAC:RES SPEC2)
- Channel 2 power spectral density (TRAC:RES PSD2)
- Frequency response (TRAC:RES FRES)
- Coherence (TRAC:RES COH)
- Cross spectrum (TRAC:RES CSP)

The query returns SPEC if the one-channel mode is selected, NETW if the two-channel mode is selected.

DISPlay**subsystem****Description:**

This subsystem has three main purposes:

- It provides commands for setting x-axis and y-axis scaling on the two displays.
- It provides access to the limit table data and many of the limit table functions.
- It provides access to the displayed data (data that has already been transformed into the current display coordinates). See the TRAC subsystem for access to the raw data from which the displayed data is derived.

The following diagram shows you the difference between data available in the TRAC subsystem and the DISP subsystem:

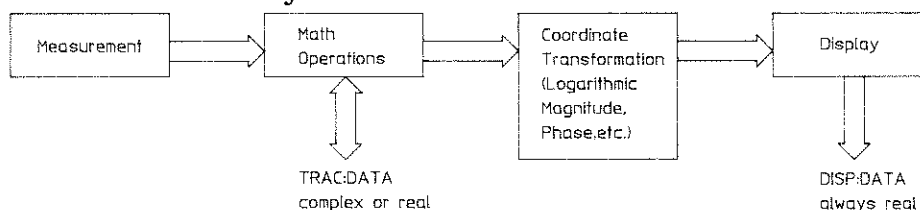

Figure 7-2. Flow of Measurement Data

After measurement data is collected, any specified math operations are performed. Data is then transformed into the specified coordinate system and sent to the display. TRAC:DATA provides access to the raw measurement data after math operations have been performed. This data can be either complex or real. DISP:DATA provides access to the displayed data, after the coordinate transformation. This data is always real.

NOTE Both TRAC:DATA and DISP:DATA allow you to take measurement data out of the analyzer. However, only TRAC:DATA allows you to put measurement data back into the analyzer.

With a few exceptions, display commands must be directed to one of the two displays: A or B. To specify a display, insert one of the following items between DISPLAY or DISP and the rest of the command:

- :A – as in DISP:A:GRAT ON
- :B – as in DISPLAY:B:LIM:BEEP?
- 1 – as in DISPLAY1:X:SPACING LIN
- 2 – as in DISP2:Y:SCAL:STAR?

Using :A or 1 directs the command to display A. Using :B or 2 directs the command to display B. If you don't explicitly specify one of the displays, the command is directed to display A.

NOTE The display to which you direct a command becomes the active display.

When HP Instrument BASIC is installed in the analyzer, additional commands are added to this subsystem. For information on these commands, see Appendix D in the HP Instrument BASIC Programming Reference.

DISP:DATA?

query

Overlapped: no
 Delayed result: no
 Pass control required: no
 Power-up state: not applicable

Example Statement: OUTPUT 711;"DISP:DATA?"

Query Syntax: DISPlay[<spec>]:DATA?

<spec> ::= ~ :A ~ | :B | 1 | 2

Returned Format: <block_data>

<block_data> takes one of two forms, depending on whether the data is ASCII-encoded or binary-encoded. When data is ASCII-encoded (DISP:HEAD:AFOR ASC):

<block_data> ::= {<point>,...<point n><LF>< ^ END>

<point> ::= the y-axis values for the 1st through nth x-axis points (n is returned with the DISP:HEAD:POIN? query)

All y-axis values are returned in NRf format.

When data is binary-encoded (DISP:HEAD:AFOR FP32 or DISP:HEAD:AFOR FP64):

<block_data> ::= #<byte> <length_bytes> {<point>}...

<byte> ::= one ASCII-encoded byte that specifies the number of length bytes to follow

<length_bytes> ::= ASCII-encoded bytes that specify the number of data bytes to follow

<point> ::= the y-axis values for the 1st through nth x-axis points (n is returned with DISP:HEAD:POIN?)

If DISP:HEAD:AFOR FP32 is specified, y-axis values are encoded as 32-bit binary floating point numbers. If DISP:HEAD:AFOR FP64 is specified, y-axis values are encoded as 64-bit binary floating point numbers.

Description:

This query dumps data from the specified display to the analyzer's output queue. Your controller can then read the data from the queue. The data returned by this query has already undergone a coordinate transform, so the y-axis values are in the current display units (returned from DISP:HEAD:YUN?).

The x-axis value for a given point is implied by the order of the points. DISP:HEAD:XOR is the x-axis value for the first point. Add DISP:HEAD:XINC to the first point's x-axis value to get the value of the second point. Add DISP:HEAD:XINC to the second point's x-axis value to get the value of the third point and so on.

DISP:GRATicule[?]**command/query**

Overlapped: no
 Delayed result: no
 Pass control required: no
 Power-up state: 1

Example Statements: OUTPUT 711;"Disp:Grat 0"
 OUTPUT 711;"DISPLAY:B:GRATICULE ON"
 OUTPUT 711;"DISP2:GRAT?"

Command Syntax: DISPlay[<spec>]:GRATicule<sp>{OFF|ON|0|1}
 <spec>::= ~:A~|:B|1|2

Query Syntax: DISPlay[<spec>]:GRATicule?

Returned Format: {0|1}<LF><^END>

Description:

Each display's graticule lines (or trace grid) can be turned on and off with this command. When a grid is turned off (DISP:GRAT OFF), it is not displayed, plotted, or printed.

The query returns 0 if the specified display's graticule is off, 1 if it is on.

DISP:HEADer**selector****Description:**

This command only selects the DISP:HEAD subsystem. Queries in this subsystem are used to determine characteristics of the data returned by the DISP:DATA query. Sending DISP:HEAD alone does nothing.

DISP:HEAD:AFORmat[?]**command/query**

Overlapped: no
 Delayed result: no
 Pass control required: no
 Power-up state: ASC

Example Statements: OUTPUT 711;"DISP:B:HEAD:AFOR FP64"
 OUTPUT 711;"DISPLAY:HEADER:AFORMAT ASCII"
 OUTPUT 711;"Disp:Head:Afor?"

Command Syntax: DISPlay[<spec>]:HEADer:AFORmat<sp>{ASCii|FP32|FP64}
 <spec>::= ~:A~|:B|1|2

Query Syntax: DISPlay[<spec>]:HEADer:AFORmat?

Returned Format: {ASC|FP32|FP64}<LF><^END>

Description:

Display data can either be ASCII-encoded or binary-encoded when it is dumped to the analyzer's output queue using the DISP:DATA query. This command lets you specify how the display data should be encoded.

NOTE Data encoding must be the same for both displays at any given time. So regardless of the display you specify when you send this command, encoding for both will be changed.

When ASC is selected, data is sent as a series of y-axis values separated by commas. The values are ASCII-encoded and are formatted as NRf decimal numbers.

FP32 and FP64 both specify binary encoding. When FP32 is selected, data is sent as a series of y-axis values within a definite length block. The values are encoded as 32-bit binary floating point numbers. When FP64 is selected, data is also sent as a series of y-axis values within a definite length block. However, the values are encoded as 64-bit binary floating point numbers.

For more information on data encoding and data transfer formats, see Chapter 4, "Transferring Data."

The query returns ASC, FP32, or FP64, depending on the option currently specified.

DISP:HEAD:NAME?**query**

Overlapped: no
 Delayed result: no
 Pass control required: no
 Power-up state: "Spectrum Chan 1" (display A)
 "Time Chan 1" (display B)

Example Statement: OUTPUT 711; "DISP1:HEAD:NAME?"

Query Syntax: DISPlay[<spec>]:HEADer:NAME?

<spec> ::= ~:A~ | :B|1|2

Returned Format: "<trace_name>"<LF><^END>

<trace_name> ::= 0 to 30 printable ASCII characters

Description:

This query returns the name of the specified display. When looking at the analyzer's screen, you will see the name in the lower-left corner of the specified display.

You can change the name with the TRAC:TITL command.

DISP:HEAD:POINTS?**query**

Overlapped: no
 Delayed result: no
 Pass control required: no
 Power-up state: 401 (display A)
 1024 (display B)

Example Statement: OUTPUT 711; "DISP2:HEAD:POIN?"

Query Syntax: DISPlay[<spec>]:HEADer:POINTS?

<spec> ::= ~:A~ | :B|1|2

Returned Format: <value><LF><^END>

<value> ::= an integer (NR1 format)

Description:

A display's x-axis is divided into discrete points. Use this query to determine how many discrete points there are along the specified display's x-axis. This is the number of points that will be dumped to the analyzer's output queue when you send the DISP:DATA query.

DISP:HEAD:PREamble?**query**

Overlapped: no
 Delayed result: no
 Pass control required: no
 Power-up state: variable

Example Statement: OUTPUT 711; "DISP:HEAD:PRE?"

Query Syntax: DISPlay[<spec>]:HEADer:PREamble?

<spec> ::= ~:A ~ |:B|1|2

Returned Format: <points>,<x_per_point>,<x_origin>,<x_increment>,
 <y_per_point>,<y_origin>,<y_increment><LF><^END>

<points> ::= number of discrete points on the display's x-axis (same as returned with DISP:HEAD:POIN?)

<x_per_point> ::= number of x-axis values per point (same as returned with DISP:HEAD:XPO?)

<x_origin> ::= x-axis value of the first point (same as returned with DISP:HEAD:XOR?)

<x_increment> ::= increment between x-axis points (same as returned with DISP:HEAD:XINC?)

<y_per_point> ::= number of y-axis values per point (same as returned with DISP:HEAD:YPO?)

<y_origin> ::= y-axis value of the lowest point on the specified trace (same as returned with DISP:HEAD:YOR?)

<y_increment> ::= optimum y-axis value per division (same as returned with DISP:HEAD:YINC?)

<points>, <x_per_point>, and <y_per_point> are integers (NR1 format). All other values are decimal numbers (NR2 or NR3 format).

Description:

This query returns seven pieces of information separated by commas. The information is useful for setting up an array to receive display data (returned from DISP:DATA?).

NOTE As the Returned Format indicates, each piece of information can be returned separately in response to its own query.

The <points>, <x_per_point>, and <y_per_point> values are used together to tell you how many values you must read after sending the DISP:DATA query. The formula is:

$$\# \text{ of values to read} = \text{<points>} \times (\text{<x_per_point>} + \text{<y_per_point>})$$

The analyzer does not return x-axis values for each data point. Instead, it provides `<x_origin>` and `<x_increment>` values so you can assign an x-axis value to each returned point. `<x_origin>` is the x-axis value for the first point. Add `<x_increment>` to the first point's x-axis value to get the value of the second point. Add `<x_increment>` to the second point's x-axis value to get the value of the third point and so on.

The values returned in `<y_origin>` and `<y_increment>` should be ignored when the value of `<y_points>` is something other than 0 (zero).

DISP:HEAD:XINCrement?

query

Overlapped: no
 Delayed result: no
 Pass control required: no
 Power-up state: 256 (display A)
 3.81E-6 (display B)

Example Statement: `OUTPUT 711;"DISP:A:HEAD:XINC?"`

Query Syntax: `DISPlay[<spec>]:HEADer:XINCrement?`

`<spec>::=~:A~|:B|1|2`

Returned Format: `<value><LF><^END>`

`<value>::=a decimal number (NRf format)`

Description:

This query returns the increment between x-axis values on the specified display. The value is only valid when the `DISP:HEAD:XPO?` response is 0.

`DISP:HEAD:XINC` and `DISP:HEAD:XOR` are used together to assign x-axis values to the points returned by the `DISP:DATA` query. `DISP:HEAD:XOR` is the x-axis value for the first point. Add `DISP:HEAD:XINC` to the first point's x-axis value to get the value of the second point. Add `DISP:HEAD:XINC` to the second point's x-axis value to get the value of the third point and so on.

Use `DISP:HEAD:XUN?` to determine units for the `DISP:HEAD:XINC` value.

DISP:HEAD:XNAME?**query**

Overlapped: no
 Delayed result: no
 Pass control required: no
 Power-up state: "Frequency" (display A)
 "Time" (display B)

Example Statement: OUTPUT 711;"DISP1:HEAD:XNAME?"

Query Syntax: DISPlay[<spec>]:HEADer:XNAME?
 <spec> ::= ~:A~|:B|1|2

Returned Format: "{Frequency|Time}"<LF><^END>

Description:

This query returns the name of the specified display's x-axis. The name tells you whether the displayed data is in the frequency or the time domain.

DISP:HEAD:XORigin?**query**

Overlapped: no
 Delayed result: no
 Pass control required: no
 Power-up state: 0

Example Statement: OUTPUT 711;"DISP:B:HEAD:XOR?"

Query Syntax: DISPlay[<spec>]:HEADer:XORigin?
 <spec> ::= ~:A~|:B|1|2

Returned Format: <value><LF><^END>

<value> ::= a decimal number (NRf format)

Description:

This query returns the x value of the specified display's first x-axis point. The value is only valid when the DISP:HEAD:XPO? response is 0. The analyzer always returns 0 when DISP:HEAD:XPO? is sent.

DISP:HEAD:XOR and DISP:HEAD:XINC are used together to assign x-axis values to the points returned by DISP:DATA?. See DISP:HEAD:XINC for more information.

Use DISP:HEAD:XUN? to determine units for the DISP:HEAD:XOR value.

DISP:HEAD:XPOints?**query**

Overlapped: no
 Delayed result: no
 Pass control required: no
 Power-up state: 0

Example Statement: OUTPUT 711; "DISP2:HEAD:XPO?"

Query Syntax: DISPlay[<spec>]:HEADer:XPOints?
 <spec>::= ~:A~ |:B|1|2

Returned Format: 0<LF><^END>

Description:

The DISP:DATA query returns data from the specified display as a series of data points. The DISP:HEAD:XPO query tells you how many x-axis values will be returned with each point.

Since each data point can only be made up of y-axis values, the DISP:HEAD:XPO query always returns 0. You can calculate the x-axis values for each point using the values returned by the DISP:HEAD:XINC and DISP:HEAD:XOR queries.

DISP:HEAD:XUNits?**query**

Overlapped: no
 Delayed result: no
 Pass control required: no
 Power-up state: "HZ" (display A)
 "S" (display B)

Example Statement: OUTPUT 711; "DISP:A:HEAD:XUN?"

Query Syntax: DISPlay[<spec>]:HEADer:XUNits?
 <spec>::= ~:A~ |:B|1|2

Returned Format: "{HZ|S}"<LF><^END>

Description:

This query tells you what units apply to the DISP:HEAD:XINC and DISP:HEAD:XOR values.

DISP:HEAD:YINCrement?**query**

Overlapped: no
 Delayed result: no
 Pass control required: no
 Power-up state: variable

Example Statement: OUTPUT 711;"DISP1:HEAD:YINC?"

Query Syntax: DISPlay[<spec>]:HEADer:YINCrement?
 <spec>::= ~:A~|:B|1|2

Returned Format: <value><LF><^END>
 <value>::=a decimal number (NRf format)

Description:

This query returns the optimum y-axis value per division for the specified trace. The value returned is the result of the following calculation:

$$(Y_{\max} - Y_{\min})/8$$

Where:

Y_{max} = the y-axis value of the highest point on the trace

Y_{min} = the y-axis value of the lowest point on the trace

The value is returned in the current y-axis units.

DISP:HEAD:YNAME?**query**

Overlapped: no
 Delayed result: no
 Pass control required: no
 Power-up state: "LogMag" (display A)
 "Real" (display B)

Example Statement: OUTPUT 711;"DISP:B:HEAD:YNAME?"

Query Syntax: DISPlay[<spec>]:HEADer:YNAME?
 <spec>::= ~:A~|:B|1|2

Returned Format: "{Delay|Imag|LinMag|LogMag|Phase|Real}"<LF><^END>

Description:

This query returns the name of the specified display's y-axis. The name tells you what kind of coordinates are being used to display the data. (Coordinates are referred to as Trace Type on the analyzer's front panel.)

DISP:HEAD:YORigin?**query**

Overlapped: no
 Delayed result: no
 Pass control required: no
 Power-up state: variable

Example Statement: OUTPUT 711;"DISP2:HEAD:YOR?"

Query Syntax: DISPlay[<spec>]:HEADer:YORigin?

<spec>::= ~:A~ |:B|1|2

Returned Format: <value><LF><^END>

<value>::=a decimal number (NRf format)

Description:

This query returns the y-axis value of the lowest point on the specified trace.

DISP:HEAD:YPOints?**query**

Overlapped: no
 Delayed result: no
 Pass control required: no
 Power-up state: 1

Example Statement: OUTPUT 711;"DISP:HEAD:YPO?"

Query Syntax: DISPlay[<spec>]:HEADer:YPOints?

<spec>::= ~:A~ |:B|1|2

Returned Format: 1<LF><^END>

Description:

The DISP:DATA query returns data from the specified display as a series of data points. The DISP:HEAD:YPO query tells you how many y-axis values will be returned with each point.

The analyzer always returns 1 in response to this query. This means that each point returned by DISP:DATA? will consist of one y-axis value.

DISP:HEAD:YUNits?**query**

Overlapped: no
 Delayed result: no
 Pass control required: no
 Power-up state: "DBVRMS" (display A)
 "V" (display B)

Example Statement: OUTPUT 711;"DISP2:HEAD:YUN?"

Query Syntax: DISPlay[<spec>]:HEADer:YUNits?

<spec>::= ~:A~ |:B|1|2

Returned Format: "[<unit>]"<LF><^END>

<unit>::=V|V2|VRMS|VRMS2|DB|DBM|
 DBVRMS|DBVPK|DEG|RAD|V/RTHZ|
 VRMS/RTHZ|V2/HZ|VRMS2/HZ|
 DBVRMS/HZ|DBVPK/HZ|DBM/HZ|S

Description:

This query tells you what unit applies to the y-axis values returned from the DISP:DATA query.

NOTE Not listed in Returned Format are the many special units that can result from math operations or the application of engineering units. However, such units are also valid responses.

DISP:LIMit[?]**command/query****Description:**

Disp:LIM is functionally equivalent to Disp:LIM:TABL. See the latter command for more details.

DISP:LIM:BEEPPer[?]**command/query**

Overlapped: no
 Delayed result: no
 Pass control required: no
 Power-up state: 0

Example Statements: OUTPUT 711;"disp2:lim:beep off"
 OUTPUT 711;"Display:A:Limit:Beeper On"
 OUTPUT 711;"DISP:LIM:BEEP?"

Command Syntax: DISPlay[<spec>]:LIMit:BEEPPer<sp> {OFF|ON|0|1}
 <spec> ::= ~:A~|:B|1|2

Query Syntax: DISPlay[<spec>]:LIMit:BEEPPer?

Returned Format: {0|1}<LF><^END>

Description:

This command enables and disables the limit-test beeper. When the beeper is enabled (DISP:LIM:BEEP ON) and the limit test fails, the analyzer beeps.

The system beeper must also be enabled (SYST:BEEP ON) if you want the analyzer to beep.

The query returns 0 if the limit beeper is off, 1 if it is on.

DISP:LIM:FAIL?**query****Description:**

Disp:LIM:FAIL is functionally equivalent to Disp:LIM:FAIL:DATA. See the latter query for more details.

DISP:LIM:FAIL[:DATA]?**query**

Overlapped: no
 Delayed result: no
 Pass control required: no
 Power-up state: 0

Example Statement: OUTPUT 711;"DISP:B:LIM:FAIL?"

Query Syntax: DISPlay[<spec>]:LIMit:FAIL[:DATA]?

<spec>::=~:A~|:B|1|2

Returned Format: <block_data>

<block_data> takes one of two forms, depending on whether the data is ASCII-encoded or binary-encoded. When data is ASCII-encoded (DISP:LIM:FAIL:HEAD:A FOR ASC):

<block_data>::={<point>,...<point n><LF><^END>

<point>::=<x_value>,<y_value>,<y_limit>,<y_flag>

These values are returned for the 1st through nth points (n is returned with DISP:LIM:FAIL:HEAD:POIN?)

All values are returned in the NRf format and are separated by commas.

When data is binary-encoded, (DISP:LIM:FAIL:HEAD:A FOR FP32 or DISP:LIM:FAIL:HEAD:A FOR FP64):

<block_data>::=#<byte><length_bytes>{<point>}...

<byte>::=one ASCII-encoded byte that specifies the number of length bytes to follow

<length_bytes>::=ASCII-encoded bytes that specify the number of data bytes to follow

<point>::=<x_value><y_value><y_limit><y_flag>

These values are returned for the 1st through nth points (n is returned with DISP:LIM:FAIL:HEAD:POIN?)

All values are returned as either 32-bit or 64-bit binary floating point numbers, depending on the setting of DISP:LIM:FAIL:HEAD:A FOR.

Description:

When a limit table is coupled to a display that has limit testing enabled, the data in that display is tested against limits specified in the table. Limits may be set for some or all of the displayed data. This query responds with those points of the specified data that failed when tested against the limits. Each point consists of four values, which are defined as follows:

<x_value>::=x-axis value of the failed point

<y_value>::=y-axis value of the failed point

<y_limit>::=y limit specified for the failed point

<y_flag>::=fail flag (0=passed, 1=failed min. limit, 2=failed max. limit)

Limit tables are defined with the LIM:TABL:DATA command. They are assigned to a display using the DISP:LIM:TABL command.

DISP:LIM:FAIL:HEADer **selector****Description:**

This command only selects the DISP:LIM:FAIL:HEAD subsystem. Sending DISP:LIM:FAIL:HEAD alone does nothing.

DISP:LIM:FAIL:HEAD:AFORmat[?] **command/query**

Overlapped: no
Delayed result: no
Pass control required: no
Power-up state: ASC

Example Statements: OUTPUT 711; "DISP:A:LIM:FAIL:HEAD:AFOR FP64"
OUTPUT 711; "DISPLAY:B:LIMIT:FAIL:HEADER:AFORMAT ASCII"
OUTPUT 711; "DISP:LIM:FAIL:HEAD:AFOR?"

Command Syntax: DISPlay[<spec>]:LIMit:FAIL:HEADer:AFORmat<sp> {ASCIi|FP32|FP64}
<spec> ::= ~:A~|:B|1|2

Query Syntax: DISPlay[<spec>]:LIMit:FAIL:HEADer:AFORmat?

Returned Format: {ASC|FP32|FP64}<LF><^END>

Description:

Data returned in response to the DISP:LIM:FAIL:DATA query can be ASCII-encoded or binary-encoded. This command allows you to specify how each limit's data should be encoded.

When ASC is selected, data is sent as a series of values separated by commas. The values are ASCII-encoded and are formatted as NRf decimal numbers.

FP32 and FP64 both specify binary encoding. When FP32 is selected, data is sent as a series of values within a definite length block. The values are encoded as 32-bit binary floating point numbers. When FP64 is selected, data is also sent as a series of values within a definite length block. However, the values are encoded as 64-bit binary floating point numbers.

For more information on data encoding and data transfer formats, see Chapter 4, "Transferring Data."

The query returns ASC, FP32, or FP64, depending on the option currently specified.

DISP:LIM:FAIL:HEAD:POINts?**query**

Overlapped: no
 Delayed result: no
 Pass control required: no
 Power-up state: 0

Example Statement: OUTPUT 711;"DISP1:LIM:FAIL:HEAD:POIN?"

Query Syntax: DISPlay[<spec>]:LIMit:FAIL:HEADer:POINts?
 <spec>::= ~:A~ |:B|1|2

Returned Format: <value><LF><^END>
 <value>::=an integer (NR1 format)

Description:

This query tells you how many points in the specified display failed when tested against a limit table.

To define limit tables, use the LIM:TABL:DATA command. To assign limit tables to one of the displays, use the DISP:LIM:TABL command. To read the values of the failed points, use the DISP:LIM:FAIL:DATA query.

DISP:LIM:LINE[?]**command/query**

Overlapped: no
 Delayed result: no
 Pass control required: no
 Power-up state: 0

Example Statements: OUTPUT 711;"Disp:Lim:Line On"
 OUTPUT 711;"DISPLAY1:LIMIT:LINE 0"
 OUTPUT 711;"DISP:LIM:LINE?"

Command Syntax: DISPlay[<spec>]:LIMit:LINE<sp>{OFF|ON|0|1}
 <spec>::= ~:A~ |:B|1|2

Query Syntax: DISPlay[<spec>]:LIMit:LINE?

Returned Format: {0|1}<LF><^END>

Description:

This command enables the specified display to show limit lines. These limit lines define the bounds within which you want the trace data to fall.

The query returns 0 if the specified display is not enabled to show limit lines, 1 if it is.

DISP:LIM:STATe[?]**command/query**

Overlapped: no
 Delayed result: no
 Pass control required: no
 Power-up state: 0

Example Statements: OUTPUT 711;"DISP:A:LIM:STAT OFF"
 OUTPUT 711;"Display2:Limit:State 1"
 OUTPUT 711;"disp:b:lim:stat?"

Command Syntax: DISPlay[<spec>]:LIMit:STATe<sp>{OFF|ON|0|1}
 <spec>::= ~:A~|:B|1|2

Query Syntax: DISPlay[<spec>]:LIMit:STATe?

Returned Format: {0|1}<LF><^END>

Description:

This command enables limit testing for the specified display. ON and 1 enable limit testing; OFF and 0 disable limit testing.

While limit testing is enabled for a particular display, the data on that display is tested against the limits each time the display is updated. When display A data fails the test, bit 8 of the Data Integrity Condition register is set. When display B data fails the test, bit 9 of the Data Integrity Condition register is set.

The query returns 0 if limit testing is not enabled for the specified display, 1 if it is.

DISP:LIM[:TABLE][?]**command/query**

Overlapped: no
 Delayed result: no
 Pass control required: no
 Power-up state: 1 (display A)
 2 (display B)

Example Statements: OUTPUT 711;"Disp2:Lim 1"
 OUTPUT 711;"DISPLAY:A:LIMIT:TABLE 8"
 OUTPUT 711;"DISP:LIM?"

Command Syntax: DISPlay[<spec>]:LIMit[:TABLE]<sp> <table_number>

<spec>::= ~:A~|:B|1|2

<table_number>::=a single integer 1 through 8 (NRf format)

Query Syntax: DISPlay[<spec>]:LIMit[:TABLE]?

Returned Format: <value><LF><^END>

<value>::=an integer (NR1 format)

Description:

This command allows you to couple one of the eight limit tables to the specified display.

If limit testing is enabled, the displayed data is automatically tested against the limit table you specify with this command. The data is tested each time the display is updated.

The query response indicates which limit table is coupled to the specified trace.

DISP:LIM:TEST?**query****Description:**

Disp:LIM:TEST is functionally equivalent to Disp:LIM:TEST:DATA. See the latter query for more details.

DISP:LIM:TEST[:DATA]?**query**

Overlapped: no
 Delayed result: no
 Pass control required: no
 Power-up state: 0

Example Statement: OUTPUT 711; "DISP:A:LIM:TEST?"

Query Syntax: DISPLAY[<spec>]:LIMit:TEST[:DATA]?

<spec> ::= ~ :A ~ | :B | 1 | 2

Returned Format: <block_data>

<block_data> takes one of two forms, depending on whether the data is ASCII-encoded or binary-encoded. When data is ASCII-encoded (DISP:LIM:FAIL:HEAD:AFOR ASC):

<block_data> ::= {<point>}, ...<point n> <LF> <^ END>

<point> ::= <x_value>, <y_value>, <y_limit>, <y_flag>

These values are returned for the 1st through nth points (n is returned with DISP:LIM:FAIL:HEAD:POIN?)

All values are returned in the NRf format and are separated by commas.

When data is binary-encoded, (DISP:LIM:FAIL:HEAD:AFOR FP32 or DISP:LIM:FAIL:HEAD:AFOR FP64):

<block_data> ::= #<byte> <length_bytes> {<point>} ...

<byte> ::= one ASCII-encoded byte that specifies the number of length bytes to follow

<length_bytes> ::= ASCII-encoded bytes that specify the number of data bytes to follow

<point> ::= <x_value> <y_value> <y_limit> <y_flag>

These values are returned for the 1st through nth points (n is returned with DISP:LIM:FAIL:HEAD:POIN?)

All values are returned as either 32-bit or 64-bit binary floating point numbers, depending on the setting of DISP:LIM:FAIL:HEAD:AFOR.

Description:

When a limit table is coupled to a display that has limit testing enabled, the data in that display is tested against limits specified in the table. Limits may be set for some or all of the displayed data. This query responds with all points of the specified data that were tested against limits, even if they did not fail those limits. Each point consists four values, which are defined as follows:

<x_value> ::= x-axis value of the tested point

<y_value> ::= y-axis value of the tested point

<y_limit> ::= y limit specified for the tested point

<y_flag> ::= fail flag (0=passed, 1=failed min. limit, 2=failed max. limit)

Limit tables are defined the LIM:TABL:DATA command. They are assigned to a display using the DISP:LIM:TABL command.

DISP:LIM:TEST:HEADer**selector****Description:**

This command only selects the DISP:LIM:TEST:HEAD subsystem. Sending DISP:LIM:TEST:HEAD alone does nothing.

DISP:LIM:TEST:HEAD:AFORmat[?]**command/query**

Overlapped: no
 Delayed result: no
 Pass control required: no
 Power-up state: ASC

Example Statements: OUTPUT 711;"DISP:LIM:TEST:HEAD:AFOR ASCII"
 OUTPUT 711;"display:b:limit:test:header:aformat fp64"
 OUTPUT 711;"DISP:LIM:TEST:HEAD:AFOR?"

Command Syntax: DISPlay[<spec>]:LIMit:TEST:HEADer:AFORmat<sp>
 {ASCIi|FP32|FP64}
 <spec> ::= ~:A ~ |:B|1|2

Query Syntax: DISPlay[<spec>]:LIMit:TEST:HEADer:AFORmat?

Returned Format: {ASC|FP32|FP64}<LF>< ^ END>

Description:

Data returned in response to the DISP:LIM:TEST:DATA query can be ASCII-encoded or binary-encoded. This command allows you to specify how each display's data should be encoded.

When ASC is selected, data is sent as a series of values separated by commas. The values are ASCII-encoded and are formatted as NRf decimal numbers.

FP32 and FP64 both specify binary encoding. When FP32 is selected, data is sent as a series of values within a definite length block. The values are encoded as 32-bit binary floating point numbers. When FP64 is selected, data is also sent as a series of values within a definite length block. However, the values are encoded as 64-bit binary floating point numbers.

For more information on data encoding and data transfer formats, see Chapter 4, "Transferring Data."

The query returns ASC, FP32, or FP64, depending on the option currently specified.

DISP:LIM:TEST:HEAD:POINTS?**query**

Overlapped: no
 Delayed result: no
 Pass control required: no
 Power-up state: 0

Example Statement: OUTPUT 711;"DISP:LIM:TEST:HEAD:POIN?"

Query Syntax: DISPlay[<spec>]:LIMit:TEST:HEADer:POINts?

<spec> ::= ~:A ~ |:B|1|2

Returned Format: <value><LF>< ^ END>

<value> ::= an integer (NR1 format)

Description:

This query tells you how many points in the specified display were tested against a limit table.

To define limit tables, use the LIM:TABL:DATA command. To assign limit tables to one of the displays, use the DISP:LIM:TABL command. To read the values of the tested points, use the DISP:LIM:FAIL:DATA query.

DISP:X**selector****Description:**

This command only selects the DISP:X subsystem. Sending DISP:X alone does nothing.

DISP:X:APERture[?]**command/query**

Overlapped: no
 Delayed result: no
 Pass control required: no
 Power-up state: 0.005

Example Statements: OUTPUT 711;"DISP:B:X:APER 0.01"
 OUTPUT 711;"DISPLAY1:X:APERTURE 16PCT"
 OUTPUT 711;"Disp:B:X:Aper?"

Command Syntax: DISPlay[<spec>]:X:APERture<sp>{{<percent>PCT}|<fraction>}

<spec> ::= ~:A ~ |:B|1|2
 <percent> ::= .5|1|2|4|8|16
 <fraction> ::= 0.005|0.01|0.02|0.04|0.08|0.16

Query Syntax: DISPlay[<spec>]:X:APERture?

Returned Format: <fraction><LF>< ^ END>
 <fraction> ::= a decimal number (NR2 format)

Description:

When group delay coordinates are used (DISP:Y:AXIS GDEL), you must select a phase-smoothing aperture. The greater the aperture you select, the greater will be the smoothing effect on the displayed data. This command allows you to select an aperture for the specified display.

The aperture is entered as a percentage or as a fraction of the current frequency span. DISP:X:APER 0.01 is the same as DISP:X:APER 1PCT. In either case, the value you send is rounded to the nearest allowable percentage.

The query response indicates which aperture is currently selected for the specified trace. The value is returned in the fractional form.

DISP:X:SPACing[?]**command/query**

Overlapped: no
 Delayed result: no
 Pass control required: no
 Power-up state: LIN

Example Statements:

```
OUTPUT 711;"Disp2:X:Spac Lin"
OUTPUT 711;"DISPLAY1:X:SPACING LOGARITHMIC"
OUTPUT 711;"DISP:X:SPAC?"
```

Command Syntax: DISPlay[<spec>]:X:SPACing<sp>{LINear|LOGarithmic}

<spec> ::= ~:A~|:B|1|2

Query Syntax: DISPlay[<spec>]:X:SPACing?

Returned Format: {LIN|LOG}<LF><^END>

Description:

Use this command to specify whether the spacing of data points along the x-axis should be linear or logarithmic.

The query returns LIN if linear spacing is selected and LOG if logarithmic spacing is selected for the specified display.

DISP[:Y]**selector****Description:**

This command only selects the DISP:Y subsystem. Sending DISP:Y alone does nothing.

DISP[:Y]:AXIS[?]**command/query**

Overlapped: no
 Delayed result: no
 Pass control required: no
 Power-up state: LOGM (display A)
 REAL (display B)

Example Statements: OUTPUT 711;"DISP:AXIS LINM"
 OUTPUT 711;"Display2:Y:Axis Magnitude"
 OUTPUT 711;"disp:axis?"

Command Syntax: DISPlay[<spec>][:Y]:AXIS<sp><axis>

<spec> ::= ~:A ~ |:B|1|2

<axis> ::= GDElAy|IMAGinary|LINMagnitude|LOGMagnitude|PHASe|REAL

Query Syntax: DISPlay[<spec>][:Y]:AXIS?

Returned Format: {GDEL|IMAG|LINM|LOGM|PHAS|REAL} <LF>< ^ END>

Description:

This command lets you specify the coordinate system to be used for the specified display. (Coordinate systems are referred to as Trace Types on the analyzer's front panel.)

DISP:Y:AXIS GDEL specifies the group delay coordinate system, which uses time on the y-axis and frequency on the x-axis. Group delay is related to phase, but shows phase delays in time rather than degrees of phase shift. The analyzer uses a smoothing aperture to define the resolution of the group delay display. This coordinate system is not allowed for time records. See DISP:X:APER for more information.

DISP:Y:AXIS IMAG specifies the imaginary coordinate system, which uses imaginary numbers for the y-axis and frequency or time for the x-axis. This coordinate system shows the imaginary component of complex data at each point along the x-axis.. If the data is real rather than complex, a y value of 0 is displayed for all x-axis points.

DISP:Y:AXIS LINM specifies the linear magnitude coordinate system, which uses magnitude for the y-axis and frequency or time for the x-axis. In addition, the y-axis scale is spaced linearly. DISP:Y:AXIS LOGM specifies the logarithmic magnitude coordinate system, which also uses magnitude for the y-axis and frequency or time for the x-axis. However, the y-axis scale is spaced logarithmically.

DISP:Y:AXIS PHAS specifies the phase coordinate system, which uses phase for the y-axis and frequency or time for the x-axis.

DISP:Y:AXIS REAL specifies the real coordinate system, which uses real numbers for the y-axis and frequency or time for the x-axis. This coordinate system shows real data or the real component of complex data at each point along the x-axis.

The query response tells you which scaling system is currently selected.

DISP[:Y]:SCALE **selector**

Description:

This command only selects the DISP:Y:SCAL subsystem. Sending DISP:Y:SCAL alone does nothing.

DISP[:Y]:SCAL:AUTO **selector**

Description:

This command only selects the DISP:Y:SCAL:AUTO subsystem. Sending DISP:Y:SCAL:AUTO alone does nothing.

DISP[:Y]:SCAL:AUTO:SINGLE **command**

Overlapped: no
Delayed result: no
Pass control required: no
Power-up state: not applicable

Example Statements: OUTPUT 711;"DISP:A:SCAL:AUTO:SING"
OUTPUT 711;"Display2:Y:Scale:Auto:Single"

Command Syntax: DISPlay[<spec>][:Y]:SCALE:AUTO:SINGLE

<spec> ::= ~:A ~ |:B|1|2

Description:

This command performs a single autoscale on the specified display. This optimizes y-axis scaling for that display.

DISP[:Y]:SCAL:CENTer[?]**command/query**

Overlapped: no
 Delayed result: no
 Pass control required: no
 Power-up state: variable

Example Statements: OUTPUT 711;"displ:scal:cent 5v"
 OUTPUT 711;"DISPLAY:B:Y:SCALE:CENTER -40 DBM"
 OUTPUT 711;"Disp:B:Scal:Cent?"

Command Syntax: DISPlay[<spec>][:Y]:SCALE:CENTer<sp><value>[<unit>]

<spec>::= ~ :A~ |:B|1|2

<value>::=a decimal number (NRf format)

<unit> options are listed in Appendix A.

Query Syntax: DISPlay[<spec>][:Y]:SCALE:CENTer?

Returned Format: <value><LF>< ^ END>

<value>::=a decimal number (NRf format)

Description:

This command allows you to define the center of a display's vertical scale. Changing the vertical-per-division value (DISP:Y:SCAL:DIV) after using this command will alter the top and bottom points of the display while keeping the center point fixed.

The unit you can send with this command depends on two things:

- The measurement data being displayed
- The coordinate system (also called trace type) being used to display the measurement data

Send the TRAC:RES query to determine which measurement data is being displayed and the DISP:Y:AXIS query to determine which trace type is being used. You can then refer to Appendix A to determine which units you can send with this command.

NOTE If you do not include a <unit> specifier when you send this command, the analyzer assumes a default unit. This default unit is not necessarily the current unit used for the vertical axis. Default units are specified in Appendix A.

The query returns the center point of the display's vertical scale. Note that only a value is returned; units are not appended. Units are returned by the DISP:Y:SCAL:UNIT query.

DISP[:Y]:SCAL:DIVision[?]**command/query**

Overlapped: no
 Delayed result: no
 Pass control required: no
 Power-up state: variable

Example Statements: OUTPUT 711;"DISP:SCAL:DIV 5"
 OUTPUT 711;"DISPLAY1:Y:SCALE:DIVISION 10"
 OUTPUT 711;"disp1:scal:div?"

Command Syntax: DISPlay[<spec>][:Y]:SCALe:DIVision<sp><value>[<unit>]

<spec> ::= ~ :A ~ | :B | 1 | 2

<value> ::= any decimal number x , where $.001 \leq x \leq 100$ (when the display units are referenced to dB)

any decimal number x , where $1 \text{ E-}36 \leq x \leq 1 \text{ E}36$ (when the display units are not referenced to dB)

<unit> options are listed in Appendix A.

Query Syntax: DISPlay[<spec>][:Y]:SCALe:DIVision?

Returned Format: <value><LF><^END>

<value> ::= a decimal number (NRf format)

Description:

Graticule lines divide a display's vertical axis into eight divisions. Use this command to define the increment between graticule lines on the specified display's vertical axis.

The unit you can send with this command depends on two things:

- The measurement data being displayed
- The coordinate system (also called trace type) being used to display the measurement data

Send the TRAC:RES query to determine which measurement data is being displayed and the DISP:Y:AXIS query to determine which trace type is being used. You can then refer to Appendix A to determine which units you can send with this command.

NOTE If you do not include a <unit> specifier when you send this command, the analyzer assumes a default unit. This default unit is not necessarily the current unit used for the vertical axis. Default units are specified in Appendix A.

The query returns the current increment between specified display's graticule lines. Note that only a value is returned; units are not appended.

DISP[:Y]:SCAL:REFerence[?]**command/query**

Overlapped: no
 Delayed result: no
 Pass control required: no
 Power-up state: INP

Example Statements: OUTPUT 711;"DISP:A:SCAL:REF CENT"
 OUTPUT 711;"Display:B:Y:Scale:Reference Start"
 OUTPUT 711;"DISP2:SCAL:REF?"

Command Syntax: DISPlay[<spec>][:Y]:SCALe:REFerence<sp>
 {CENTer|STARt|STOP|INPut}
 <spec> ::= ~:A~|:B|1|2

Query Syntax: DISPlay[<spec>][:Y]:SCALe:REFerence?

Returned Format: {CENT|STAR|STOP|INP} <LF> < ^ END >

Description:

This command lets you use one of three parameters to select the top, center, or bottom of the specified display as a vertical axis reference point. STOP selects the top, CENT selects the center, and STAR selects the bottom. The reference point selected with this command remains fixed when the vertical-per-division value (DISP:Y:SCAL:DIV) is changed.

A fourth parameter, INP, enables automatic reference tracking. Automatic reference tracking selects vertical scaling values based on the input range of the channel supplying the measurement data.

Your selection of trace type and measurement data affects reference level tracking. When the logarithmic magnitude trace type is selected, the top reference is kept at the input range. When the linear magnitude trace type is selected, the bottom reference is kept at zero. When the real or imaginary trace types are selected, the center reference is set to 0 (zero). In addition, when linear magnitude, real, or imaginary trace types are selected, the vertical-per-division value is changed so that the top reference is \geq the input range. (See the DISP:Y:AXIS command for information on specifying the trace type.)

Reference level tracking is not allowed for the phase (DISP:Y:AXIS PHAS) and group delay (DISP:Y:AXIS GDEL) trace types. It is also not allowed for frequency response, coherence, and user-defined measurement data. (See TRAC:RES for information on measurement data).

The vertical axis reference point is changed and automatic reference tracking is disabled by the following commands: DISP:Y:SCAL:CENT, DISP:Y:SCAL:STAR, and DISP:Y:SCAL:STOP. Reference level tracking is also disabled by these commands: DISP:Y:SCAL:AUTO:SING and DISP:Y:SCAL:DIV. (When DISP:Y:AXIS is LOGM, DISP:Y:SCAL:DIV might not disable reference level tracking.)

This command does not allow you to specify a value for the reference point. This must be done with the DISP:Y:SCAL:CENT, DISP:Y:SCAL:STAR, or DISP:Y:SCAL:STOP command.

The query response tells you what kind of vertical-axis scaling is currently selected.

DISP[:Y]:SCAL:STARt[?]**command/query**

Overlapped: no
 Delayed result: no
 Pass control required: no
 Power-up state: variable

Example Statements: OUTPUT 711;"Disp:Scal:Star 10"
 OUTPUT 711;"display2:Y:scale:start -40dBVrms"
 OUTPUT 711;"DISP:A:SCAL:STAR?"

Command Syntax: DISPlay[<spec>][:Y]:SCALe:STARt<sp><value>[<unit>]

<spec> ::= ~:A ~ |:B|1|2

<value> ::= a decimal number (NRf format)

<unit> options are listed in Appendix A

Query Syntax: DISPlay[<spec>][:Y]:SCALe:STARt?

Returned Format: <value><LF>< ^ END>

<value> ::= a decimal number (NRf format)

Description:

This command allows you to define the bottom of a display's vertical scale. Changing the vertical-per-division value (DISP:Y:SCAL:DIV) after using this command will alter the top and center points of the display while keeping the bottom point fixed.

The unit you can send with this command depends on two things:

- The measurement data being displayed
- The coordinate system (also called trace type) being used to display the measurement data

Send the TRAC:RES query to determine which measurement data is being displayed and the DISP:Y:AXIS query to determine which trace type is being used. You can then refer to Appendix A to determine which units you can send with this command.

NOTE If you do not include a <unit> specifier when you send this command, the analyzer assumes a default unit. This default unit is not necessarily the current unit used for the vertical axis. Default units are specified in Appendix A.

The query returns the bottom point of the display's vertical scale. Note that only a value is returned; units are not appended. Units are returned by the DISP:Y:SCAL:UNIT query.

DISP[:Y]:SCAL:STOP[?]**command/query**

Overlapped: no
 Delayed result: no
 Pass control required: no
 Power-up state: variable

Example Statements: OUTPUT 711;"DISP:A:SCAL:STOP 1"
 OUTPUT 711;"display2:Y:scale:stop 10dbvrms"
 OUTPUT 711;"Disp:Scal:Stop?"

Command Syntax: DISPlay[<spec>][:Y]:SCALe:STOP <sp> <value>[<unit>]

<spec> ::= ~:A ~ |:B |1|2

<value> ::= a decimal number (NRf format)

<unit> options are listed in Appendix A

Query Syntax: DISPlay[<spec>][:Y]:SCALe:STOP?

Returned Format: <value><LF>< ^END>

<value> ::= a decimal number (NRf format)

Description:

This command allows you to define the top of a display's vertical scale. Changing the vertical-per-division value (DISP:Y:SCAL:DIV) after using this command will alter the center and bottom points of the display while keeping the top point fixed.

The unit you can send with this command depends on two things:

- The measurement data being displayed
- The coordinate system (also called trace type) being used to display the measurement data

Send the TRAC:RES query to determine which measurement data is being displayed and the DISP:Y:AXIS query to determine which trace type is being used. You can then refer to Appendix A to determine which units you can send with this command.

NOTE If you do not include a <unit> specifier when you send this command, the analyzer assumes a default unit. This default unit is not necessarily the current unit used for the vertical axis. Default units are specified in Appendix A.

The query returns the top point of the display's vertical scale. Note that only a value is returned; units are not appended. Units are returned by the DISP:Y:SCAL:UNIT query.

DISP[:Y]:SCAL:UNITs[?]**command/query**

Overlapped: no
 Delayed result: no
 Pass control required: no
 Power-up state: "DBVRMS" (display A)
 "V" (display B)

Example Statements: OUTPUT 711;"Disp:Scal:Unit ""Deg""
 OUTPUT 711;"DISPLAY2:Y:SCALE:UNITs 'DBVPK'
 OUTPUT 711;"disp1:scal:unit?"

Command Syntax: DISPlay[<spec>][:Y]:SCALe:UNITs<sp>{'|'}<unit>{'|'}

<spec>::= ~:A~|:B|1|2

<unit>options are listed in Appendix A

Query Syntax: DISPlay[<spec>][:Y]:SCALe:UNITs?

Returned Format: "<unit>"<LF><^END>

Description:

Use this command to select a unit for the specified display's y-axis.

The unit you can send with this command depends on two things:

- The measurement data being displayed
- The coordinate system (also called trace type) being used to display the measurement data

Send the TRAC:RES query to determine which measurement data is being displayed and the DISP:Y:AXIS query to determine which trace type is being used. You can then refer to Appendix A to determine which units you can send with this command.

The query returns the y-axis unit currently being used for the specified trace.

